



© Marshall Day Acoustics

version 8

Sound Insulation Prediction Program

Users Manual

Marshall Day Acoustics

2014

Contact Details

Marshall Day Acoustics

PO Box 5811

Auckland 1141

New Zealand

Ph: 64 9 379 7822

Fax:64 9 309 3540

www.marshallday.com

insul@insul.co.nz

Contents

Limitations

Getting Started

- Installation
- First look

Theory

- Mass Law
- Critical Frequency
- Modulus of Elasticity
- Damping
- Free Field
- New materials
- Ribbed and Corrugated Panels
- Multiple Layers
- Plate resonances
- Elastic Materials
- Laminated Panels
- Inelastic Materials
- Orthotropic Materials
- Composite Steel Floors
- Porous Materials
- Panel Size
- Double Panels

Cavity infill

- Effect of Absorptive Material
- Timber Studs
- Resilient Rails
- Rubber Isolation Clips
- Ceiling Supports
- Steel Studs
- Double Studs
- Double and Triple Glazing
- Leakage
- Impact Noise

Joists

- Joist properties
- Setting joist properties

Impact Sound Limitations

- Agreement with measured data
- Agreement with measured data at low frequencies.

Rain Noise Theory

- Introduction

Drop Theory
Laboratory Rainfall (ISO 140-18)
Natural Rainfall

Flanking

Materials Editor

Using INSUL

Insul tabs
Single Panels
Double Panels
Triple Panels
Roof
Saving and retrieving files
Comparison
Reference
Outdoor to Indoor Transmission
Calculation Form
Extra Data Required
Angle of Incidence
Sound Source
Octaves versus 1/3 Octaves
Standards
D2m,nT
Composite TL Calculations
Auralisation
Remote Update of INSUL USB key.
Upgrading INSUL keys
Clipboard
Settings
Custom Logo
Limitations

Limitations

Users should be aware of its limitations, like any prediction tool it is not a substitute for test data. Comparisons with test data show that it is generally within 3 STC points for most constructions.

Getting Started

Installation instructions for single user version

Before installing INSUL you should close any open applications and log on as a user with sufficient access rights to install programs. This normally means having Administrator rights.

Install INSUL

1. When you purchased INSUL you will have received a USB key . Plug this into a spare usb port on your computer. In most systems that are connected to the Internet Windows will automatically locate and install the correct drivers for the Safenet key. This will take perhaps 30 seconds to a minute, after which you will get a message that the drivers are installed and then the small LED in the tip of the key will light up.

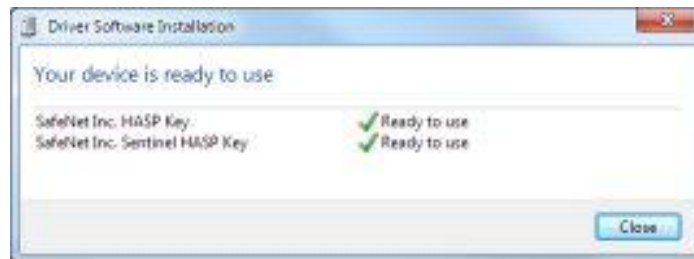

2. If this does not happen then run the file HASPUserSetup.exe from the INSUL USB flash drive. This will install the drivers for the USB key. Now plug the USB key into a spare USB port. The small LED in the tip of the key will light up.
3. You should install INSUL from the USB FLASH DRIVE by double clicking on the file "Steup.exe".
4. Read the instructions on the Welcome page and click the next button.

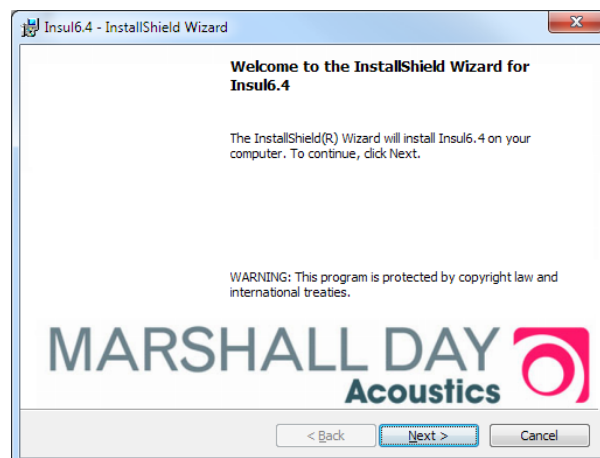

5. Read the Software license Agreement and if you accept the terms of the licence, click the Yes button.
6. If you wish to read the INSUL release notes you may scroll down the Readme Information then click the Next button.
7. Type your name and the company name in the appropriate fields and click the Next button.
8. To choose a particular destination directory for INSUL's files click the Browse button. To accept the default destination directory click the Next button.
9. To change the Program folder where program icons will be stored enter a new folder name in the Program Folder field, otherwise leave the default folder name. Click the Next button.
10. If you are satisfied with the settings click Next to begin copying the necessary files.
11. You can now run the program from the normal Windows "Start ", "All Programs" menu. The About form should display. INSUL is now ready to use.



Installation Instructions for Network INSUL

INSUL can be run over a Local Area Network (LAN). It is not necessary to install INSUL on every client computer as it can be run from one network location. INSUL should be installed on one computer on the network, usually this would be the network file server. The network Hasp key should be plugged into the computer which has INSUL installed on it. Each user will need access rights to the folder where INSUL has been installed.

On each other client computer on the network you must install the Hasp drivers using the HASPUserSetup.exe file on the USB flash drive. This file can also be downloaded from the INSUL website (www.insul.co.nz) Once these Hasp drivers have been installed the client computer will be able to communicate with the network key to determine if any licenses are available.

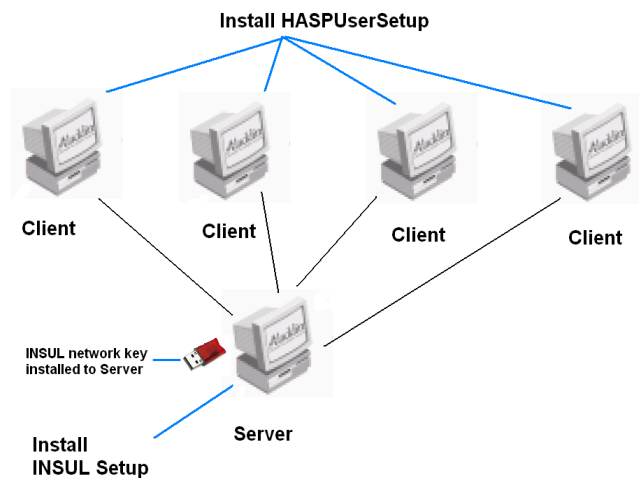

Install INSUL Setup

File Server

1. Insert the INSUL USB flash drive into the server. Start the INSUL installation program by running the program setup.exe in the folder INSUL.
2. Read the instructions on the Welcome page and click the next button.
3. Read the Software license Agreement and if you accept the terms of the licence, click the Yes button.
4. If you wish to read the INSUL release notes you may scroll down the Readme Information then click the Next button.
5. Type your name and the company name in the appropriate fields and click the Next button.
6. To choose a particular destination directory for INSUL's files click the Browse button. To accept the default destination directory click the Next button. Note that this folder must be accessible by all users on the network.

7. To change the Program folder where program icons will be stored enter a new folder name in the Program Folder field, otherwise leave the default folder name. Click the Next button.
8. Once the installation process has finished you can start INSUL on that computer (this is the computer labelled Server in the diagram above).
9. INSUL should start and display the About screen. This should have the version number of INSUL, the version number of the key and the serial number.

Client Computers

10. On each other networked computer that you want to run INSUL from you will need to install the Hasp key drivers. Run the file HASPUsersetup.exe on each computer (These are the computers labelled Client in the diagram above).
11. You should now be able to run INSUL from each computer by running the application file Insul80.exe from the network folder where you have installed it.
12. The operation of the key software can be monitored by starting an internet browser such as Internet Explorer or Firefox and typing into the address bar localhost:1947. This shows the Hasp keys connected to the system and allows one to change and monitor various settings.

First Look

Start with a very simple example of predicting the transmission loss of a sheet of gypsum plasterboard. In the bottom left hand quarter of the window you will see what looks like a notebook with tabs sticking up. These tabs are labelled panel 1, panel 2, frame 1, frame 2, glazing, etc. Initially **panel 1** is selected and the Material is Gypsum plasterboard. Note that the materials database is customised for different countries and may have different material names to what is shown in this manual.

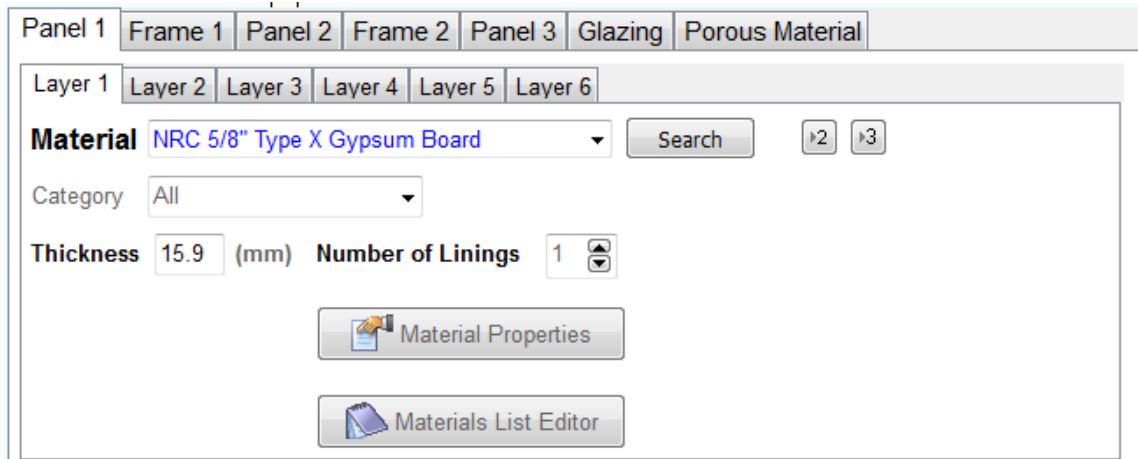

One may see what other materials are available by clicking on the little triangle at the right hand side of the **materials** box, a drop down list will appear and any of the available materials can be selected by clicking on the list. In this case click on Gypsum plasterboard.

Enter the thickness of the material by either clicking in the **thickness** box or by pressing the **tab** key and deleting the previous value and entering the new one. Entering a thickness of zero will cause an arithmetic error.

One can force a calculation by either clicking on the little picture of a lightning bolt  in the top left-hand corner on the toolbar or by clicking on the **Panel 1** tab or by pressing F9 or enter. The graph on the right hand side will then display the 1/3 octave band transmission loss as a function of frequency and the STC or Rw will be displayed in the area just above the graph together with the calculated octave bank transmission loss spectrum.

For European countries the index Rw can be displayed instead of STC (click the Evaluation Standard radio group to switch between STC and Rw). It is easy to add multiple layers by clicking on the up and down arrows to the right of the **No. Linings** box. For layer 1 you cannot have less than one lining, but for the other layers you can have zero linings.

To predict the performance of a wall consisting of a single row of timber studs with a layer of 12.5mm Gypsum plaster board either side click on the tab labelled **panel 2**. As before select the material, thickness and number of layers (eg Gypsum, 12.5mm and 1 respectively). Now that you have specified the linings on each side click on the tab labelled Frame 1. This will give you the display shown below.

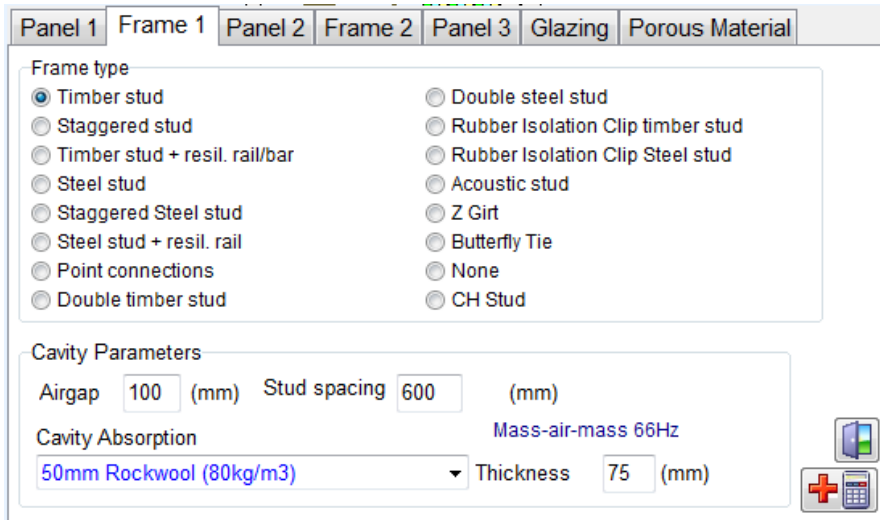

Choose timber stud, enter the width of the airgap (in this case the thickness of the studs eg 100mm) and the spacing of the studs (eg 600mm) and then either click the tab labelled **wall**, or press F9 or click the calculate button on the toolbar. As before the STC is displayed in the box in the top of the screen, the graph shows the 1/3 octave band sound transmission losses (together with STC curve) and the octave band values are given in the table to the right of the STC value.

It is now easy to check the effect of changing to steel studs by clicking on the option for steel studs. You can use the comparison tool for highlighting the change on the graph.

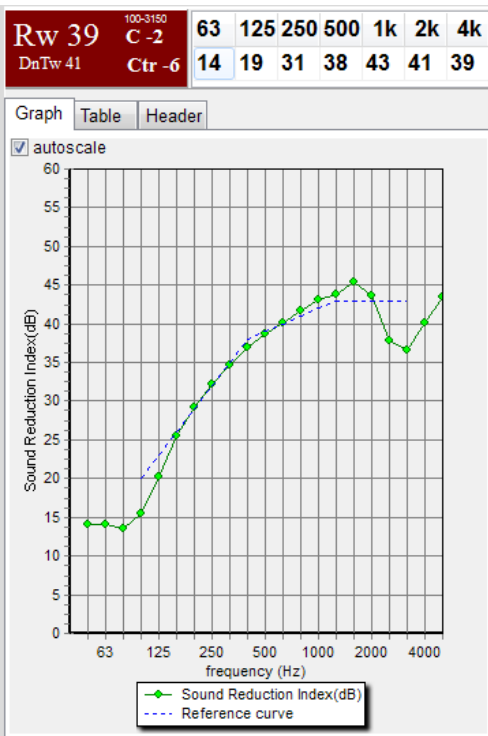

Theory

Mass Law

The mass law can model walls consisting of a single homogeneous panel quite well up to about half the critical frequency. The mass law predicts the transmission loss (TL) from the surface mass (mass of 1m^2 of the panel) and the frequency. If the surface mass is in kg/m^2 and the frequency is in Hz , then $TL = 20 \cdot \log_{10}(f \cdot m) - 48$. The TL increases by 6 dB for each doubling of the surface mass or frequency.

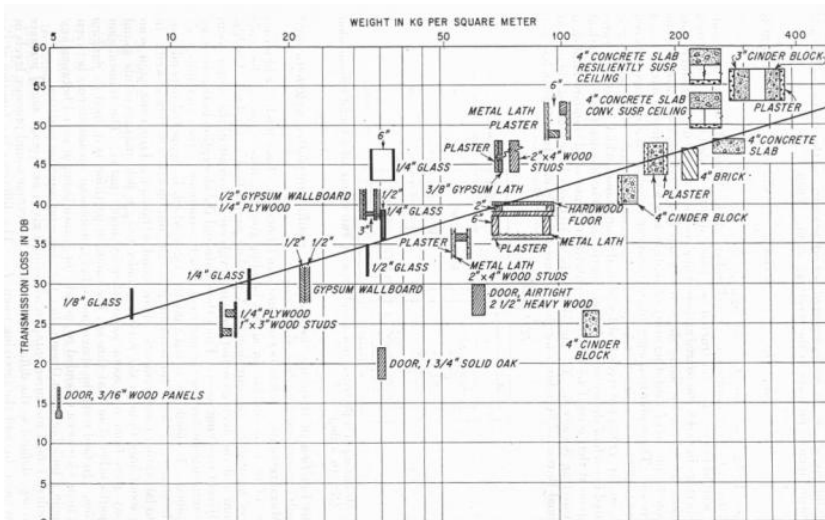

A simple explanation of the mass law is that the motion of the panel is controlled by its inertia, the panel behaving as a limp mass, and the displacement or velocity of the panel reduces as the mass of the panel is increased or as the vibration frequency increases (because it is less easy to make the panel change direction more frequently).

To predict the performance of a material using the mass law one needs only to know the density of the material and the thickness of the material.

The mass law is a good approximation for the great majority of materials at low and mid frequencies. In typical concrete thicknesses (>100mm) shear waves become important in addition to bending waves and the Transmission Loss is less than predicted by the mass law.

INSUL models this effect and the influence of shear waves can be seen at high frequencies where the TL increase at only 6 dB per octave again.

The mass law predicts the Transmission Loss of most materials up to the critical frequency. Above this frequency Cremer's theory is used to predict the Transmission Loss.

The critical frequency is high for thin limp materials, such as lead, steal, plastics. For thick stiff materials the critical frequency can be low (brick, plywood).

Critical Frequency

At low frequencies most materials behave as simple limp masses and the mass law can predict the Transmission Loss. At higher frequencies the bending stiffness of materials becomes important and at a certain frequency known as the critical frequency, the transmission loss dips well below the mass law.

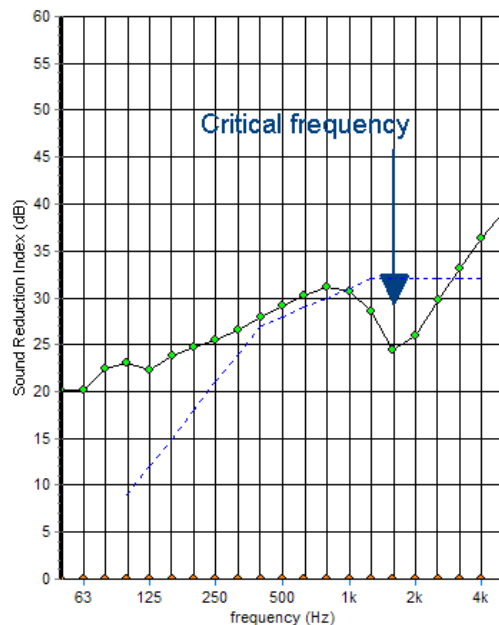

Above the critical frequency the TL increases at 12 dB/octave (doubling at frequency) so that as the frequency increases the TL can increase to above the mass law.

At the critical frequency the wavelength of bending waves in the panel equals the wavelength of airborne sound.

For homogeneous materials the product of surface mass and critical frequency is a constant, thus doubling the surface mass (by doubling the thickness of the panel) will halve the critical frequency. This constant can be calculated if the elastic modulus (also known as Youngs Modulus) of the material is known. Alternatively it can be inferred from a Transmission Loss test by examining the curve of TL versus frequency to determine the critical frequency. (Knowing the surface mass for that test).

Modulus of Elasticity

The critical frequency of a panel is determined by the Modulus of Elasticity (sometimes known as Young's modulus) and the thickness of the panel. For most normal materials the product of the surface mass (kg/m^2) and the critical frequency is a constant and this simple relationship can be used to quickly determine the coincidence frequency of any given thickness. This constant is called f_{cm} in INSUL for want of any recognised term. For most building materials this constant falls in the range 10,000 to 1000,000 $\text{Hz kg}/\text{m}^2$, with gypsum plasterboard being about 30,000 $\text{Hz kg}/\text{m}^2$. The moduli of elasticity have been determined for a range of building materials and are built into INSUL, but it is easy to adjust these by opening the materials properties dialog box and entering one's own values.

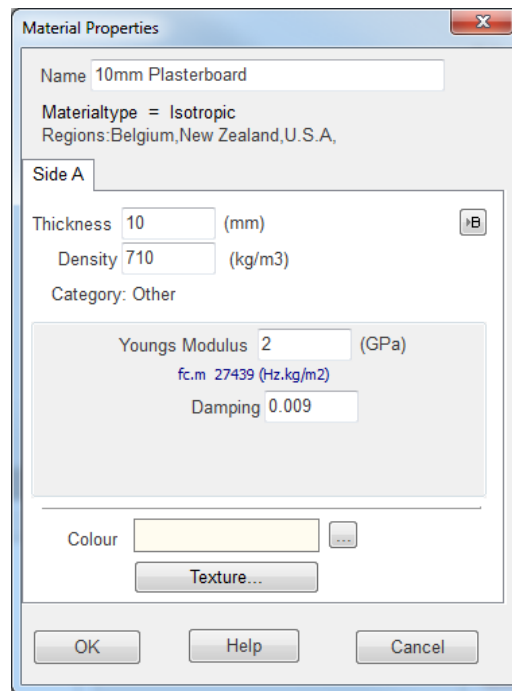

The image shows a 'Material Properties' dialog box for '10mm Plasterboard'. The dialog box contains the following fields and options:

- Name: 10mm Plasterboard
- Materialtype = Isotropic
- Regions: Belgium, New Zealand, U.S.A.
- Side A: (selected)
- Thickness: 10 (mm)
- Density: 710 (kg/m³)
- Category: Other
- Youngs Modulus: 2 (GPa)
- $f_{c.m}$: 27439 (Hz.kg/m²)
- Damping: 0.009
- Colour: (yellow swatch)
- Texture... (button)
- OK, Help, Cancel (buttons)

Damping

The internal damping affects the transmission at and above the critical frequency. Generally it is found that a damping factor of 0.01 is a reasonable starting point for most building materials, but you can play around with this to get the best match with experimental data.

Free Field

Almost all sound reduction testing and calculations are undertaken with diffuse sound fields on both sides of the wall. In this case, sound is incident on the wall at all possible angles of incidence. However, there are many instances in real life where sound arrives at the panel at a single angle of incidence and the transmission loss is somewhat different to the diffuse field case. INSUL can predict the performance of single panels (not double or triple panels) at a single angle of incidence. This is most significant at high frequencies around the coincidence or critical frequency.

Starting from version 7.0 INSUL can predict the sound reduction of a single panel (such as glazing) at particular angles of incidence. This is relevant to a situation where the sound source is outdoors (in a free field) and the sound arrives at the window at a single angle of incidence, and could be quite important in a situation where sound is incident on the partition at near grazing incidence. But first we must overcome a conundrum. In classical acoustic theory the sound transmission loss (aka sound reduction index) is defined as the ratio of incident intensity to transmitted intensity. At 90° incidence the incident intensity goes to zero (because the projected partition area at 90° is zero). But the sound transmission index also goes to zero. So how much sound is transmitted?

Rindel¹ has proposed an alternative definition that avoids these problems and enables straight forward calculation of the transmitted noise. Rindel has proposed a definition of the external transmission loss (R_E) that uses the ratio of energy densities on both sides of the partition instead of incident intensity. For an incident plane wave the energy density is related to the spatial average of the sound pressure squared, while on the receiver side the sound field is assumed to be diffuse and the energy density is again related to the sound pressure squared. Thus on both sides of the wall the quantities are easily measurable and calculatable.

$$R_E = 10 \text{ Log} \left(\frac{\langle p_s^2 \rangle S}{\langle p_R^2 \rangle A} \right)$$

Where p_s is the sound pressure on the source (free field) side, p_R the sound pressure on the receiver side (diffuse field), S is the area of the wall and A is the equivalent absorption area in the receiving room. Note that the energy reflected from the panel is included in the value p_s

¹ Rindel, J.H. "Sound Radiation from Building Structures and Acoustical Properties of Thick Plates" COMETT-SAVIOR Course, Noise Control in Buildings, CSTB, Grenoble, France.

New Materials

To model a new material generally 3 parameters are needed, the density of the material, the modulus of elasticity, and the internal damping of the panel. These are adequate to define a large number of normal materials (INSUL calls these isotropic materials because their properties are the same in all directions). Starting with version 6.4 INSUL can also model orthotropic, elastic core and inelastic core materials, see the relevant topics for how to add these materials to the materials databases.

The density is usually easy to determine either by direct measurement or from manufacturers data. The modulus of elasticity can be determined from the surface mass and critical frequency determined from a TL test on one particular thickness of the material. Manufacturers can often provide data on the elastic modulus since it is usually needed for strength and deflection calculations for building materials. The damping constant can be determined from measurement or from TL test data. If no data is available it is reasonable to use a value of 0.01 which is very typical of many building materials.

In general it is best if you have manufacturers test data on some thickness of a single panel of the material. If you do have the TL for new material, then the recommended procedure is as follows:

Enter the data as a ref spectrum in the table page. You then choose a similar material if possible from the menu. Set the thickness to the correct thickness and alter its properties using the "materials constants" button on the Panel 1 page to open up the "material properties" dialog box. You either enter the density of the material if you know it or adjust the density in the "material properties" dialog box until you get the low frequencies as correct as possible. Then you alter the "fcm" constant or Young's Modulus until you get the critical frequency dip as close as possible to the correct frequency, then you alter the damping until the high frequencies match as well as possible. Once you have worked out the best combination of density, fcm and damping, then you can open up the Materials Editor. Then in future you can select the new material from the menu.

If you do not have any test data on the material then you need to know the density of the material, the Modulus of Elasticity and if possible the internal damping of the material (if damping is not known set it to 0.01). Enter this data in the "material properties" dialog box, once you have iterated to a set of properties for the material that give a good fit you can then take these properties and enter them into the Materials Editor

An example with 19mm thick gypsum plaster board is shown below. The material constants have been altered to get good agreement with the manufacturers test data. These parameters can then be stored as "19mm Gypsum plaster board" for use in future.

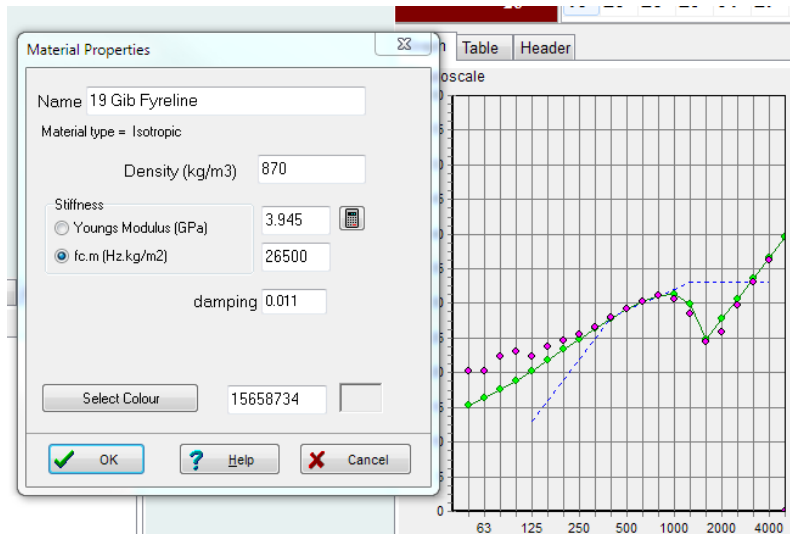

If you do not have any test data on the material then you need to know the density of the material, the Modulus of Elasticity and if possible the internal damping of the material (if damping is not known set it to 0.01). Enter this data in the "material properties" dialog box with the radio button "Youngs Modulus" selected. Then click on the calculator icon to have INSUL calculate fcm for you. This data (density, fcm and damping) can now be entered into the file "materials.txt" which should be in the sub-directory from which INSUL is run.

Material Types

Most materials are isotropic, that is their properties (such as mass, stiffness and damping) are the same in all directions. Therefore when entering new materials into the Materials Editor you should generally choose the "isotropic" option for the material "type". Exceptions are corrugated materials such as steel roof sheets, or concrete slabs cast onto profiled metal pans, these are examples of orthotropic materials (materials having different properties in different directions).

Ribbed and Corrugated Panels

Thin materials are often corrugated or ribbed to increase their stiffness and hence ability to span larger distances between supports. This can dramatically lower their TL by lowering the critical frequency (in the direction of the corrugations). The bending stiffness is different in the direction of the corrugations compared to the direction at right angles to the corrugations. Panels which have differing stiffness in each direction are known as orthotropic. Their sound transmission properties are well predicted by simple theories developed by Heckl and more recently by Windle and Lam.

To model a corrugated or ribbed panel click the Panel Profile button on the input page to open the Profile Form dialog. At the top of this form is a drop down menu of various standard profiles. The profile dimensions are stored in an external text file "profile.txt" and additional profiles can be added to this list.

If the panel profile you are interested in is not in this list then you can define your own custom profile. Click on the type of profile (i.e. flat, corrugated, or trapezoidal) and input data on the depth and pitch of the corrugations, or the various dimensions of a trapezoidal shaped panel in the spaces shown on the drawings. Clicking on the button will display the two coincidence frequencies for the orthotropic panel. The L_c/L_w parameter that is shown is the ratio of the width of the crown of the profile to the length of the web of the profile. This parameter is from

Windle and Lam (Proceedings of the Institute of Acoustics Vol 16 part 2 (1994) "A Simple Empirical Method for Predicting the Sound Reduction of Single Skin Cladding") and for values between 0.5 - 3 the algorithms of Windle and Lam are used. Closing the dialog Box by clicking on OK will calculate the STC and TL of the panel.

Multiple Layers

When two or more layers of a material are fixed together they generally do not behave the same as a single layer of increase thickness. For instance two layers of 12.5 mm plasterboard do not give the same performance as one layer of 25 mm plasterboard. At low frequencies the TL of both is the same as their combined mass, but the coincidence frequency of the 2 layers of 12.5 mm plasterboard are the same as each individual layer, whereas the 25 mm thick plasterboard has a coincidence frequency half that of the 12.5 mm thick panel. INSUL takes account of this and additional layers can be modelled accurately by entering the number of layers in the number of layers field.

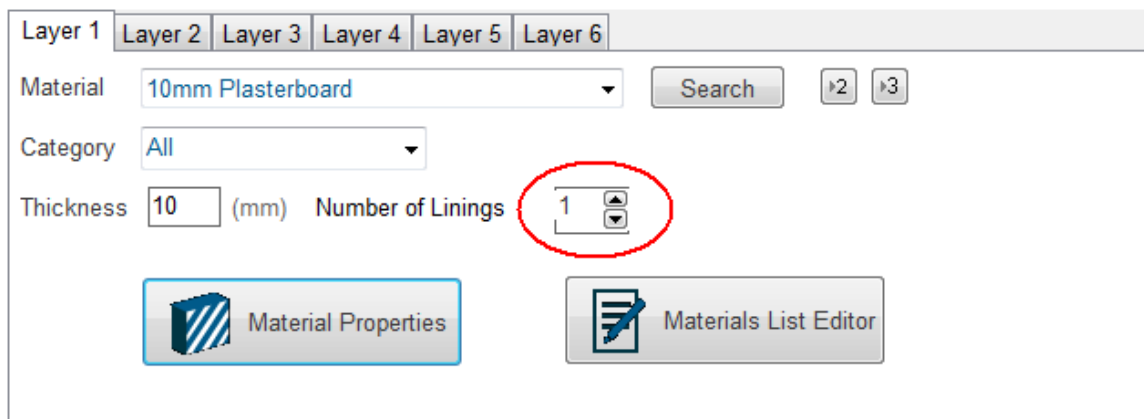

By using the inner and outer layer pages you can for instance have 3 layers of 16 mm plasterboard and 2 layers of 6 mm plywood.

This model assumes that the multiple layers are only lightly fixed together. Most normal fixing methods would fulfil this assumption, for instance screws, spot gluing, nailing etc. However, if the layers are intimately bonded together for instance by a full coverage of glue (particularly a rigidly setting glue), then it would be more accurate to model the panel as a single panel of total thickness equal to the combined thickness of the multiple layers.

Plate Resonances

At low frequencies the sound insulation of a partition can be affected by resonances of the stiffened plates formed by the frame supports (typically timber or steel studs) and the linings or layers fixed to them (typically gypsum board or particle board panels). An illustration of what the first mode will look like is shown below (with acknowledgements to Morse).

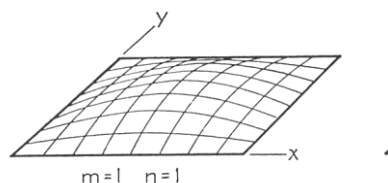

From experimental results it appears that this effect is only significant on sound transmission when panels are rigidly fixed to both sides of the studs. The frequency of the dip at low frequencies that would normally be associated with the mass-air-mass resonance is pushed to higher frequency. A prediction for a steel stud wall with and without allowance for this effect is shown below. The experimental data is shown by the pink dots, the prediction in green does not account for plate resonances, the prediction in blue does. It can be seen that allowing for the plate resonance improves the prediction at low frequencies.

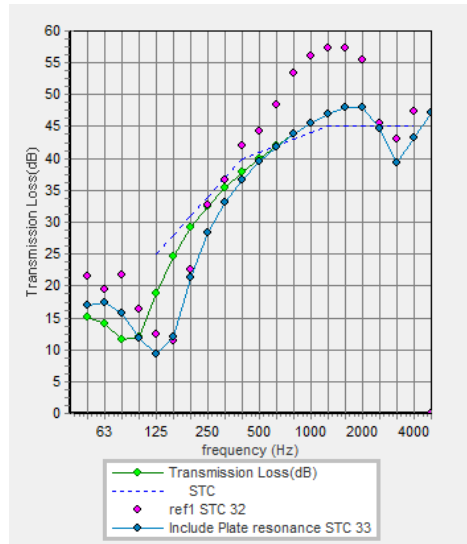

This effect is most important for small stud spacing's say (16" or 400mm), it is not so noticeable with stud spacing's of 24" (or 600mm).

Elastic Core Materials

INSUL can now predict the performance of panel materials that have a compressible or elastic core (also inelastic cores). Such materials are often made with thin steel sheets as exterior facings (typically 0.5mm thick) with an expanded polystyrene core 70 - 250 mm thick. A typical product is the Kingspan KS1000 panel which is widely used for instance, in the UK.

These types of panel have many useful construction properties such as good thermal insulation, ability to span long distances, and a pre-finished surface which speeds construction times. They are commonly used in industrial and commercial buildings. However they have a very significant dip in their sound insulation performance in the middle of the frequency range (commonly around 1kHz) which combined with their light weight means that they have only modest sound reduction properties.

INSUL can accurately predict their performance (including this dip) and also more importantly can predict the sound insulation performance when combined with other materials, either with additional linings to increase the surface mass, or as part of a cavity wall or roof/ceiling construction.

There are a variety of standard elastic cored materials in INSUL's standard materials file and more can be added either by requesting the developers to add specific materials or by modifying or extending the materials database file. The properties that define an elastic core material are the skins (density, thickness, damping and stiffness) and the core (density, thickness, Modulus of elasticity, damping and "plateau").



Laminated Panels

Laminated panels are often used for sound insulation purposes. The most important is probably laminated glass in which a plastic material such as Polyvinyl Butyral is used as an interlay (or core) between two layers of glass. This is often done for safety reasons, but also has an acoustic benefit.

The interlay has 2 benefits, it can reduce the overall stiffness of the laminated panel (thus increasing the critical frequency) and it can increase the damping (thus reducing the dip at the critical frequency and increasing the transmission loss above the critical frequency).

An example is shown below of a comparison between a single sheet of 6mm thick glass, versus 2 sheets of 3mm glass with a layer of PVB between, the overall rating is increased from about R_w 32 to R_w 39.

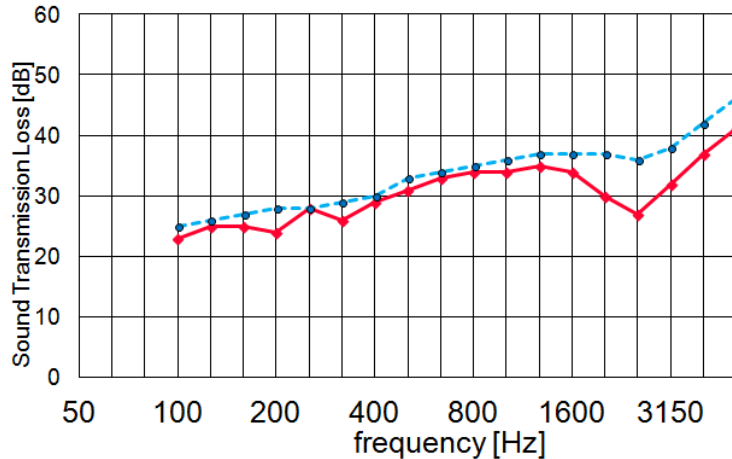

From release 7.0.8 INSUL can model these as elastic core materials. Thus the user can experiment with different thicknesses of glass (as Side A and Side B) and different inter-layers (Core) to optimise the performance. There are a number of standard inter-layers such as DuPont's Butacite® that can be used from a drop down list in the materials editor.

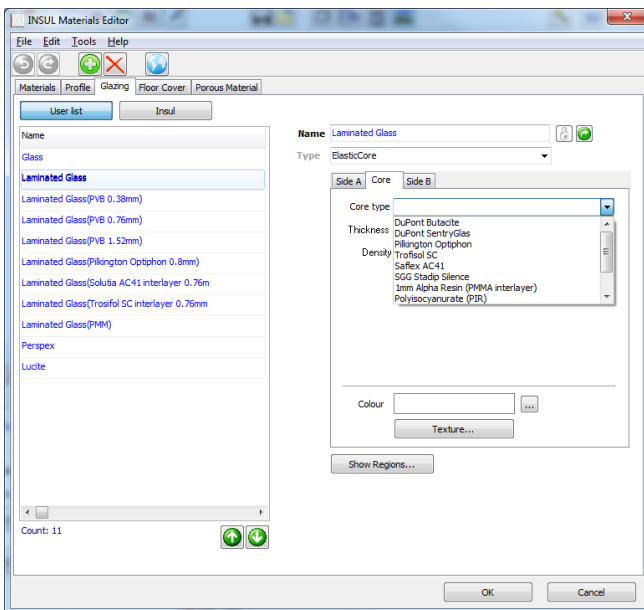

While the primary motivation of this development was laminated glass, this model could be used for other types of laminated materials including gypsum plasterboard with visco-elastic inter-layers.

Inelastic Core Materials

INSUL can predict the sound insulation of panels with a stiff core and external skins. A typical example is Speedwall which has lightweight concrete core inside a thin steel casing.

Because the core is very stiff inelastic core materials behave quite differently to elastic core materials but the data entered into the materials file is identical except that the material type in the Materials Editor is selected as "Inelastic ". For inelastic core materials the internal damping and plateau are not used and are not displayed in the materials properties form.



Material Properties

Name SpeedWall panel (400kg/m2)

Materialtype = InElastic Core
Regions: Australia, New Zealand,

Side A Core Side B

Thickness 0.6 (mm)

Density 7800 (kg/m3)

Category: Wood

Youngs Modulus 210 (GPa)
f.c.m 97499 (Hz.kg/m2)
Damping 0.090

Colour [Swatch] ...

Texture...

OK Help Cancel

Orthotropic Materials

An orthotropic material is one that has pronounced differences in two or more directions at right angles to each other.

From version 6.4 INSUL can model orthotropic materials that have different stiffness in the plane of the panel. Previously INSUL could model corrugated or ribbed materials and this facility continues, but now a material that is not profiled but has different stiffness in the X and Y directions can be entered into the software by specifying the ratio of stiffness in the x and y direction.

The predictions are based on Heckl's paper "Untersuchungen An Orthotropen Platten" Acustica Vol 10 (1960). In versions 7.0 or earlier the simplified equations were used, however these do not include the effects of damping explicitly and do not cover the central portion of the frequency range. In version 8.0 and later a full numerical solution of Heckl's equations has been implemented. This is computationally intensive and some older and lesser powered computers may show a noticeable lag when computing orthotropic panels.

Composite Steel Floors

A common method of constructing concrete floors is to use a trapezoidal steel pan onto which the concrete is poured. The floor is relatively stiff because of the ribbing in one direction and the steel pan adds stiffness to the system by the composite action of the steel which has a high elastic modulus and is spaced away from the neutral axis. So the floors constructed this way are relatively light and stiff, not good characteristics for sound insulation generally.

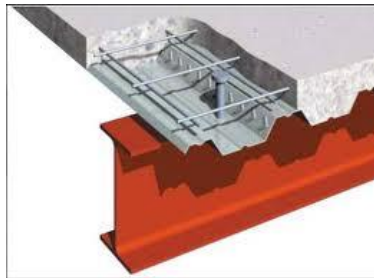

The different stiffnesses in the directions parallel and perpendicular to the steel profile give the floor different critical frequencies in each direction, that is the panel is orthotropic

Calculation of the bending stiffnesses in each direction is not straight forward because the steel adds to the stiffness as do the corrugations. INSUL uses a method published in ANSI/SDI C-2011 Standard for Composite Steel Floor Deck - Slabs.

The parameters of the floor are entered in the materials editor (and can temporarily be modified in the properties editor).

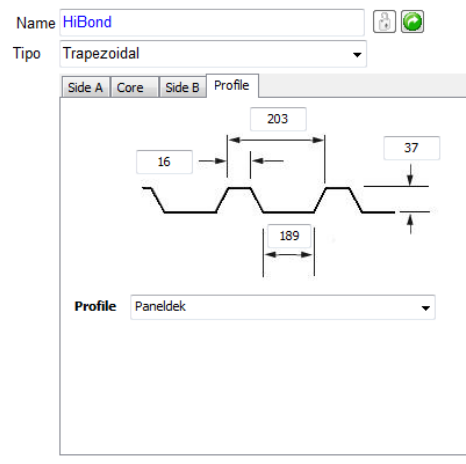

Porous Facing

A porous material such as fibreglass or mineral wool can be used as a sound attenuating layer, either by itself, or as a facing to a solid barrier. The porous layer attenuates sound partly by reflecting sound (due to the impedance change between air and the material), and partly by converting sound energy into heat as the sound waves travel through the material.

From Version 6.4, INSUL can now predict the sound reduction index of a layer of porous absorber and also the effect of a porous absorber used as a facing on a partition. Click on the Porous Facing tab and select one of the absorptive materials from the drop down box.

Tick the *Add to overall* check box to add the transmission loss of the porous facing to the transmission loss from the Panel 1, Panel 2, Wall or Ceiling tabs. The drawing should correctly display the thickness and colour of the material you have chosen.

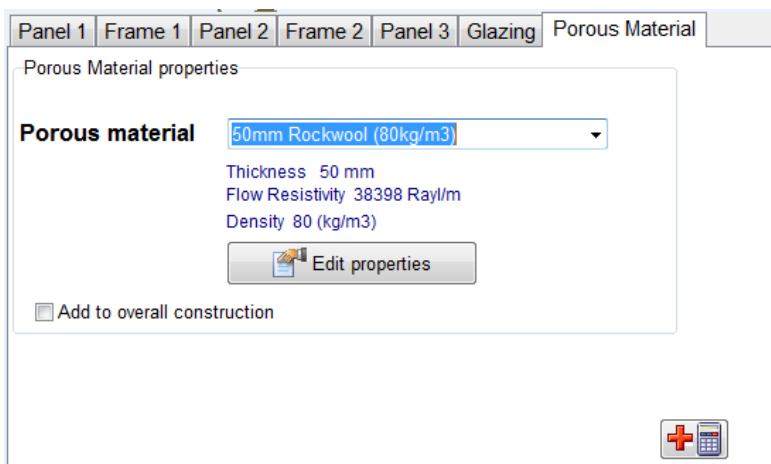

Panel Size

The size of the panel can have an effect on the measured sound transmission loss. Small panels have a low radiation efficiency at low frequencies and so appear to have a higher TL than larger panels of the same material. INSUL predicts this effect using an expression developed by Sewell. In INSUL the adjustment is called as Sewells correction. This correction is normally turned on and the panel size is set to 2.7 x 4.0 m. You can turn this correction off or set a different panel size in the panel dimensions dialog box which is accessed via the button on the toolbar. 

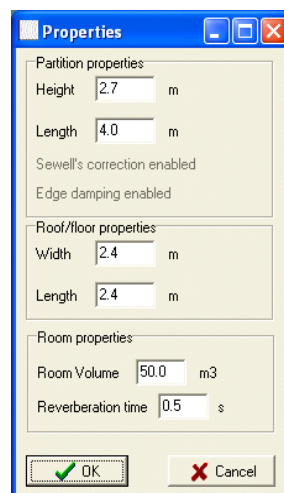

You can also turn off edge damping in the settings form. The edge damping factor models the energy loss that occurs at the edge of a normal surrounding structure. This is significant for very heavy partitions in normal constructions. In some laboratory tests and some unusual situations the partition may not be solidly connected to the surrounding structure and so the energy loss is much less, in these situations the edge damping can be turned off.

Double Panels

While it is rather simple and accurate to predict the TL of single panels, it is more difficult to predict walls that have two panels separated by a space. However, since this is such a common type of construction and since it can improve performance considerably various techniques have been developed. Indeed this is the main reason for using INSUL since it makes a complicated task quick and easy.

The easiest situation to understand and explain is two panels separated by an airspace with an absorptive blanket in the space between the panels. There is assumed to be no connection between the panels. At low frequencies the stiffness of the air between is so high relative to the inertia of the panels that the two panels are effectively locked together and move as one. The TL is simply predicted from the mass law using the combined mass of the two panels. As the excitation frequency increases the inertia of the panels increases, at the mass-air-mass resonance frequency the inertia of the panel is cancelled by the stiffness of the air and the two panels move out of phase with each other.

As the frequency increases further the TL increases at a much greater rate than the mass law (up to 24 dB/octave). At even higher frequencies the separation of the panel becomes less than $\frac{1}{2}$ a wavelength and the TL increases at 12 dB/octave.

The screenshot shows the 'INSUL' software interface with the 'Frame 1' tab selected. The 'Frame type' section contains a list of radio button options: Timber stud (selected), Staggered stud, Timber stud + resil. rail/bar, Steel stud, Staggered Steel stud, Steel stud + resil. rail, Point connections, Double timber stud, Double steel stud, Rubber Isolation Clip timber stud, Rubber Isolation Clip Steel stud, Acoustic stud, Z Girt, Butterfly Tie, None, and CH Stud. The 'Cavity Parameters' section includes input fields for 'Airgap' (100 mm) and 'Stud spacing' (600 mm), a 'Cavity Absorption' dropdown menu set to '50mm Rockwool (80kg/m3)', and a 'Thickness' field (75 mm). A 'Mass-air-mass 66Hz' label is positioned above the thickness field. A small drawing of a wall cross-section is visible in the top right corner of the settings panel.

To model a double panel or cavity wall click on the tab labelled wall and select the type of frame that best describes the connections between the two sides of the wall. Note that a drawing of a cross section of the wall appears in the panel above the input page showing the type of wall you have selected.

Timber stud walls are walls in which the linings on both sides of a frame are rigidly fixed to each other, this is the most common type of wall.

Steel studs are a common type of wall framing in non-load bearing situations (e.g office walls) which can be modelled by INSUL.

Double stud walls are modelled reasonably well as double panels without connections.

Enter the spacing between the inner faces of the two linings and the spacing between studs.

Cavity Infill

Effect of Absorptive Material

In a cavity wall sound will be transmitted from the source side into the cavity. If the cavity is empty then the sound will build-up inside the cavity and this reduces the performance of the overall wall. This much like an empty room with no carpet or furnishings, the sound reverberates and echoes around the space. By placing an absorber into the cavity this build-up is reduced and the performance of the wall is improved.

The effect is most noticeable when the two sides of the cavity wall are completely separated, because then the only transmission path through the wall is through the air in the cavity. In walls that have solid connections between the two sides (such as with a common stud wall) the structural path by the connections/studs will short circuit the cavity, and the influence of the cavity infill or absorption is not so great.

For double stud walls which have very few connections the cavity absorption can improve the overall sound transmission rating by 8 to 10 dB, compared to an empty cavity. For simple single stud or common stud walls the improvement might only be 3 dB.

The improvement is proportional to the acoustical performance of the cavity infill or absorber. Thicker and denser absorbers will perform better, however there is a low of diminishing returns and even for double stud walls there is often only small benefit to be gained by increasing the cavity absorber above about 30 kg/m³ and 100mm thickness.

A further benefit of using a cavity absorber is the reduction in the resonance frequency of the cavity wall. Typically a plasterboard wall will have a resonance frequency in the region of 100 Hz, and this can be reduced by about 20 % by placing an absorber in the cavity. This will improve the low frequency performance of the wall. From version 8.0 onwards this shift in resonance frequency is modelled more accurately by modelling the cavity as an equivalent fluid using the properties predicted from the flow resistance of the absorber. Thus as the flow resistivity of the cavity infill is increased the resonance frequency will decrease (in previous versions it was either adiabatic (no infill) or isothermal (infill present) with nothing in between).

INSUL can predict the performance of double panel walls if there is an absorptive blanket in the cavity between the panels or if the cavity is empty. The type of absorptive blanket can be selected from the drop down list.

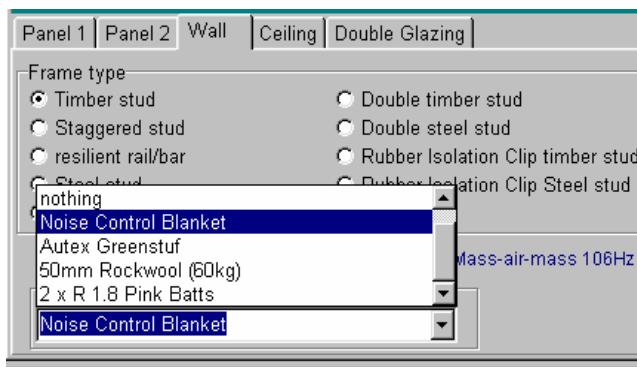

The absorptive blanket has several related effects, it dampens the mass-air-mass resonance, it dampens cavity modes which otherwise provide coupling between the two panels, and it reduces the reverberation in the cavity thus reducing the build up of sound in the cavity (One might say these are just different ways of looking at the same physical effect).

The absorptive blanket can be fibreglass, rockwool, polyester fibre, wool, or open celled plastic foam. Additional materials can be entered into the Materials Editor. The information required is the description of the material, its thickness, its flow resistivity, its density, and a value representing the colour that will be displayed. Because the method of modelling the effect of different materials is empirical it should be used within limitations. Do not use materials thinner than 25 mm or thicker than 100 mm and do not use materials less than 500 Rayls/m or more than 60,000 Rayls/m.

A special case is double glazing for which INSUL has a special empirical routine.

Timber Studs

A common form of construction is to use timber studs to make a framework and line either side with plasterboard or similar panel materials. Timber studs are usually 100 x 50mm in cross section but can be smaller or larger depending on structural requirements. Timber studs act as very stiff, light connections between panels and can be modelled to acceptable accuracy as line connections between panels.

Thus the option on the wall page labelled timber studs uses line connections between panel 1 and 2 to calculate TL.

Should you need to model other forms of construction that rigidly connect between two panels along lines, then you can use this option.

From this discussion it is apparent that this option is only valid where the panels are rigidly connected and the panels make connection along with whole length of the stud. If a resilient element is placed between the stud and the panel then the TL will in general be increased above what is predicted from line connections.

Staggered Studs

A question often asked is:

When a construction is calculated with double (wood)studs or staggered studs the results change dramatically. There isn't much constructional difference between double studs or staggered, both have no contact from the inside panel to outside, so should not the difference in acoustical terms should be comparable.

The answer lies in the detail of their respective construction. A staggered stud wall usually has a common top and bottom plate (see picture below), so there is a direct bridge between the sides of the wall. Insul models this as a line connection at 2.7 metres separation. However a double stud wall has two completely separate rows of studs, and so no structural connection between the two sides and therefore a much higher sound insulation performance.

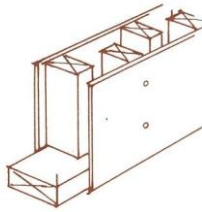

Staggered Stud wall construction

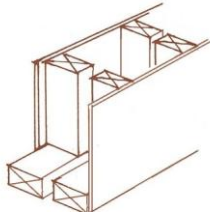

Double Stud wall construction

Resilient Rails

Resilient rails are used in partition walls to increase the TL. They are normally fixed to timber studs, with the wall or ceiling linings fixed to the resilient rail rather than directly to the stud. The function of the rail is to prevent direct vibration transmission via the stud by acting as a soft spring between linings and stud. Resilient rails are usually steel channels folded in such a way as to be quite springy. They are normally fixed in horizontal lines at 600 mm centres. They are very easy to install wrongly however and with inexperienced workmen the chances are that the wall will not achieve the predicted or lab performance.

Rubber Isolation Clips

An improved performance can be achieved with a metal bracket incorporating a rubber or neoprene isolation element. A good example is the RSIC-1 clip from Sound Isolation system (www.soundisolationsystem.com).

This fixes to the stud or joist and holds a metal channel to which the wall lining is screwed. The rubber or neoprene ensures a high degree of isolation from the wall frame and sound insulation can approach a double frame wall performance. It is also much more reliable than resilient rail.



Ceiling Supports

In the case of a ceiling it is also possible to introduce a resilient element. Normal practice is different in different countries. In North America it is common to use a 13 mm resilient metal channel. In Australia it is common to use resilient clips (eg Rondo or Gyprock or RSIC) while in New Zealand the Gib Ceiling batten can be used to provide isolation. The RSIC clips can also be used in a ceiling and as in a wall they provide a high degree of isolation.

Steel Studs

Steel studs are used to construct framed partition walls. In some countries they are used extensively almost to the exclusion of timber studs. They generally provide much higher sound transmission loss performance than timber studs because they are far less rigid than timber studs. Typically steel studs would be C or Z shaped in cross section, made of 0.55 mm thick steel and come in various cross sectional widths (51, 63, 92 mm wide). From the test data that is available steel studs seem to work about as well as a resilient rail.

In version 5.5 an option to predict steel studs with a resilient rail has been added, this predicts better performance at higher frequencies as the degree of decoupling between the two leaves increases.

In version 6.1 an "acoustic stud" option for frame type has been added. This should predict the performance of new steel studs that are specifically designed to improve sound transmission loss of plasterboard walls using steel studs (eg from Knauf, Lafarge or Winstone/Rondo).

In version 7.0 an option to predict CH studs has been introduced, these are typically robust steel studs used to form Shaft risers in multi-storey buildings and are shaped somewhat like a C on top of an H, hence the name. Typically the stud will accommodate a 25 mm thick board which provides the fire rating required for shafts. In version 8 the options have been expanded to include steel studs of 0.55mm (26 gauge) or 1.0 - 1.6 mm (20 - 16 gauge) steel thickness.

Z Girt

A Girt is a horizontal structural member in a framed wall (The corresponding member in a roof is a purlin)

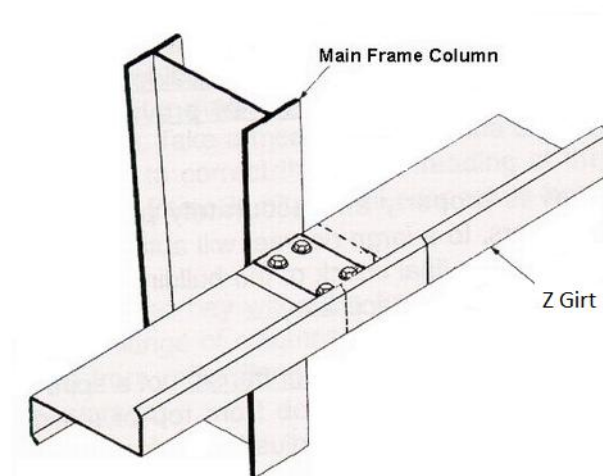

Z Girts are used in many countries in the construction of industrial buildings that are typically clad with profiled steel sheets. Z Girts are typically steel of 1.2mm thickness, bent to a Z profile and fastened horizontally to steel frames, with the weatherproof cladding fixed to the Girt.

The Z Girt modelled in INSUL is of 1.2mm thickness. If a girt has a steel thickness greater than this then INSUL may over predict its performance and it may be better to use a solid connection (eg timber stud). This connection may also be used for steel purlins of 1.2 mm thickness

Butterfly Ties

Butterfly ties are steel wires used to structurally connect separate masonry walls. Their name derives from their shape and they are predominantly used in the United Kingdom. They are laid between brick courses across the gap between the two walls.



Double Studs

Double studs provide the ultimate in performance for framed partition walls. They are constructed by erecting two separate frames, usually 25mm apart, and lining the outside of each frame typically means the chances are that the wall will not achieve the predicted or lab performance with 1 or 2 layers of plasterboard.

Because there is no physical contact between each side of the wall, the only transmission path is via the air cavity, and provided this has an absorbent blanket very high TL's can be achieved. In practice flanking transmission would often prevent the very high TLs predicted at high frequencies, but in extreme cases where measures have been taken to prevent flanking TL's of 60—70 dB at 1 kHz and above can be achieved (e.g. adjacent rooms on concrete floating floors).

Double and Triple Glazing

A special empirical routine is built into INSUL to predict the performance of double- and triple glazing. This is more accurate than selecting glass as panel 1 and glass as panel 2 and then selecting no infill in the wall section.

In version 5 and later there is an option to have different glazing materials such as laminated glass, or clear plastic. This goes under different trade names such as Perspex, Lucite, Lexan, etc.

Leakage

Leaks can be modelled by entering the height, depth and length of the leak (see diagram below).

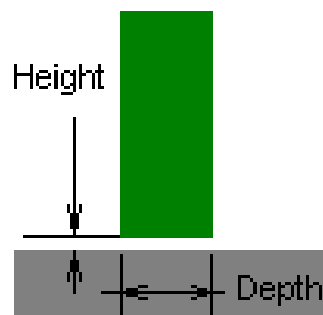

Doors (assume leak is full perimeter).

No seals:	leak height = 1.2mm
Weather stripping:	leak height = 0.5mm
Magnetic seals:	leak height = 0.2mm

Timber framed walls

No acoustic seal around the perimeter of the wall:

leak height = 0.6mm (assume leak is full perimeter and
leak length = perimeter of wall).

(Note: if part of the perimeter is sealed then reduce the length of the leak accordingly).

Impact Noise

Impact noise is most often created by footfall, as well as from closing cupboards and scraping chairs, in adjacent apartments. By their nature, impact events transmit vibration energy straight into the structure of a building. These vibrations can then radiate as acoustic energy in adjacent spaces. Impact noise is a common issue in apartment buildings and terraced houses. In the past, impact insulation performance has only been considered for vertically adjacent spaces (such as apartments that are vertically stacked, one on top of the other). This is reflected in the established theory for impact noise which has generally addressed only vertical transmission.

However, impact noise is transmitted in all directions once it enters the building structure, thus consideration of horizontal and diagonal impact noise can also be required in many situations. In particular, as footfall noise is efficiently radiated through concrete floor structures, horizontal impact noise radiation (that is, between horizontally adjacent spaces, on the same floor level) can often be a problem in large, concrete apartment buildings. INSUL's impact insulation procedure is based on Cremer's theory of point force excitation, and so can be used to evaluate vertical impact noise radiation for massive, rigid homogeneous constructions (typically concrete constructions). The model depends on the mass, bending stiffness and the damping of the floor, as well as its impedance (the floor impedance can be thought of as the resistance of the floor to excitation by the point source). INSUL 6.0 does not calculate impact noise radiation in the horizontal or diagonal directions nor for light weight timber-joist floor constructions.

There are several standardised devices used for assessing the impact insulation performance of a floor construction. The most common device is a standardised tapping machine. A tapping machine comprises five metal hammers, each weighing 500 grams, which are dropped onto the test floor from a height of 40 mm. Each hammer hits the test floor twice a second meaning that the tapping machine generates 10 impacts onto the floor every second.

The noise generated from the continuous impacting of the tapping machine hammers on the floor is measured in the room underneath the test floor. These Impact Sound Pressure Levels are then normalised and used to determine the impact insulation (IIC and $L_{n,w}$) ratings.

Resilient floor coverings such as carpet and cork can act as an elastic layer between the noise source and the floor structure and thus reduce the amount of impact energy that is transferred into the floor.

Because floor coverings are relatively thin, improvements in impact noise radiation are generally achieved at high frequencies. Typically, a floor covering will not be able to significantly reduce impact noise at frequencies any less than 500 Hz - 1 kHz. For homogeneous floor covers with

known material constants, theoretical models can be used to predict the reduction in impact noise achieved by the floor cover.

However, in practice the majority of floor covers are not homogeneous. For example, where hard floor surfaces are installed, such as tiles and timber (parquet) floors, a proprietary resilient (acoustic) underlay can be installed between the finished floor surface and the floor construction, to provide extra damping. Thus the 'floor cover' may consist of, say, a tiled floor surface and a resilient underlay, and so is not homogeneous.

To account for this, the effects of resilient floor coverings are commonly derived from laboratory and field measurements. Two sets of impact insulation tests are conducted: one set on the bare floor construction; the other on the same floor construction but with the addition of the floor cover. The difference in the two sets of measured impact sound pressure levels gives the effective improvement in impact insulation. This measured improvement can be applied to similar bare construction types (in the case of concrete floor structures, this means the measured improvement can be applied to concrete floors of varying thicknesses) to model the floor cover's effect on impact insulation for different constructions. INSUL uses this method (rather than a theoretical model) to calculate the effect of floor coverings.

Like floor covers, ceilings can be used to improve impact insulation performance. Typically, a plasterboard or similar lightweight ceiling is installed beneath a floor construction. The ceiling is generally installed on joists or hangers which are mounted to the underside of the floor and insulation (fibre glass, polyester or similar) can be installed in the resulting air cavity. Also, the ceiling linings can be fixed into place on resilient elements (such as resilient clips of steel suspension grid systems).

When considering the effect of a ceiling on impact noise, there are two transmission paths to consider:

1. Airborne transmission of noise through the ceiling cavity: Noise radiated from the underside of the floor structure can travel through the air in the ceiling cavity, then through the ceiling linings and into the receiving room. This noise path is effected by the inclusion of insulation in the cavity, insulation will reduce the amount of noise transmitted through the ceiling.
2. The second noise path is through the support structure for the ceiling: energy from the floor structure can transfer directly through the joists or hangers that are used to mount the ceiling linings, and into the ceiling linings themselves. This path is quite distinct from the airborne transmission path. Noise transmitted along this path can be reduced by using resilient connection to mount the ceiling lining (such as steel hangers, or rubber mounts).

IIC (Impact Insulation Class) is a single number rating for floors. It is calculated or derived from 1/3 octave band Normalised Impact Sound Pressure Level data by a method described in American Society for Testing Materials (ASTM E989). This method was evolved to predict performance for footfall and other impact type sounds.

The higher the IIC value for a floor construction, the better its impact insulation performance.

To determine the IIC rating, a standard shaped curve (the blue curve on the graph) is slid down from above until the sum of the deviations of the green test curve above the blue curve add up to just less than 32, (provided that no single deviation at any frequency is more than 8). By looking at where the green curve (the Normalised Impact Sound Pressure Level) is above the blue curve (the IIC curve) you can tell what frequencies are determining the IIC rating.

The IIC rating can be applied to any type of floor construction (including concrete and timber floor constructions), however care should be taking when comparing IIC ratings for different constructions. For example, concrete and timber floor constructions sharing a common IIC value can, subjectively, sound quite different from each other.

$L_{n,w}$ is an alternative single number rating for floors. Like the IIC rating, $L_{n,w}$ uses 1/3 octave band Normalised Impact Sound Pressure Level data, but derives its rating in accordance with ISO standard (ISO 717/2).

The higher the $L_{n,w}$ value for a floor construction, the worse its impact insulation performance. (Note that this is the converse of the IIC rating system).

To determine the $L_{n,w}$ rating, a standard shaped curve (the blue curve on the graph) is slid down from above until the sum of the deviations of the green test curve above the blue curve add up to just less than 32, (there is no restriction on the size of a deviation at a single as there is with the IIC method).

Both the IIC and $L_{n,w}$ ratings are evaluated from the frequency range 100-3150 Hz. IIC and $L_{n,w}$ ratings for a given floor construction vary from each other considerably and must not be compared directly to each other to evaluate performance.

Joists

Joist spacing and floor modal response

Joist spacing or, for walls, stud spacing has traditionally been used in Insul when modelling the performance of cavity constructions. The spacing of the joists is used to determine the total length of line connections which join the two sides of a cavity construction as required by Sharp's classic theory.

Observations from measured data suggest that the modal response of a section of the floor/roof effects measured sound levels. From Version 6.4, Insul's calculations for impact sound and rain noise include effects from the influence of modal response of a section of the floor/roof layers which is bounded by the length of the floor and its joists. Therefore the joist spacing becomes significant.

The frequencies of the primary and secondary modes of the floor section are calculated based on theory described in Warburton. At these frequencies, the predicted sound level in the receive room increases moderately above the average response of the floor. Modal effects tend to occur in the mid-frequency region. Insul does not allow for modal effects above the critical frequency of the floor layers.

Joist properties

From Version 6.4, Insul impact sound and rain noise prediction routines include consideration of the joists which form part of the floor/roof construction. Theory from Gibbs et al (2008) is used to estimate the influence of joists on the impedance of the floor/roof construction in the low frequency region.

The density, bending stiffness and damping of the joists may be specified, as can the cross-sectional depth and width of the joists. These parameters are used to determine the impedance/admittance of the joists, which is relevant for light weight floors and roofs. In particular, in the low frequency region the impedance of the joists can be greater than that of the floor/roof layers and, given the large wavelengths of the sound in this frequency region, can control the performance of the overall construction.

The low frequency region where the joist impedance can be influential is dependent on the joist spacing as well as the bending wave speed of the floor/roof layers which in turn depends on the critical frequency of the roof/floor layers.

Joists properties are not significant for massive floor structures such as concrete floors.

Setting joist properties

Joist depth and spacing may be set on the Floor tab.

Joist density, bending stiffness, damping and width can be set by clicking on the Joist properties button on the Floor tab, which opens a new window.

From the Joist Properties window the type of joists may be selected.

When the joist type is set to *Automatic* Insul will model either:

Timber joists with a density of 490 kg/m³, bending stiffness of 4.95 GPa and damping of 0.035. Timber joists are assumed to have a rectangular cross-section.

ZGirts, when a ZGirt ceiling is selected, with a density of 7800 kg/m³, bending stiffness of 210 GPa and damping of 0.01.

When the joist type is set to *Custom Joists* the Custom Joists box will become active and the joist density, bending stiffness and damping may be adjusted. Custom joists are assumed homogeneous with a rectangular cross section. Composite style joists cannot be modelled.

The joist depth and width can also be adjusted from the Joist Properties window.

The joist length is automatically set to equal the floor length.

Impact Sound Limitations

Agreement with measured data

Users should be aware of the limitations of the Insul predictions, like any prediction tool it is not a substitute for test data. Comparisons with test data show that Insul is generally:

- +/- 3-5 Ln,w/IIC points for most massive constructions which include a concrete floor.
- +/- 3-6 Ln,w/IIC points for most light weight floor constructions where the combined thickness of the floor layers is less than approximately 25-35mm.

The transition between thin, light weight floor constructions of less than 25-35mm and massive floor constructions such as concrete which are 75mm or thicker involves a transition from the force function for light weight floors according to Brunskog & Hammer to the classical impact force theory of Cremer. Accordingly, impact sound insulation predictions in the intermediate region can be less accurate. Based on available test data, which is somewhat limited, Insul is generally +/-5-10 Ln,w/IIC points for relatively thick, light weight floor constructions where the combined thickness of the floor layers is approximately 35-75mm.

Agreement with measured data at low frequencies

Variability of both measured and predicted sound levels at low frequencies, below about 100Hz, is much greater than at higher frequencies. The variability may be caused by many factors including the larger wavelengths of sound in the low frequency region, the relatively small size of test samples and natural modes of vibration of the test panel, its supporting structures such as joists and the receiving room.

Insul impact sound insulation predictions may vary from measured data in individual one-third octave bands in the low frequency region by 10 Ln,w/IIC points or more. Care must be taken when low frequency impact sound insulation methods are being designed.

Examples

- Insul comparison with measured impact sound pressure levels for a thin, light-weight floor construction: 2 layers of 15 mm plywood (NRC test IIF-96-062). The Insul predicted level is Ln,w 88dB.

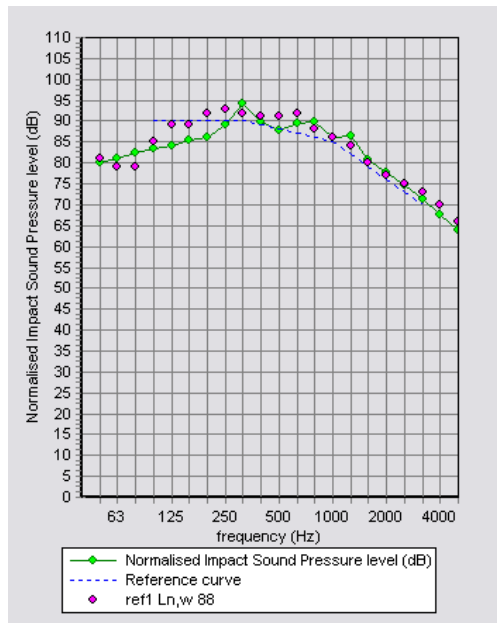

Rain Noise Theory

Introduction

An international standard for the measurement of rain noise in laboratories was released in 2006—ISO 140-18 Acoustics—Measurement of sound insulation in buildings and of building elements—Part 18: Laboratory measurement of sound generated by rainfall on building elements.

From Version 6.3, INSUL can predict levels of rain noise measured according to ISO 140-18. INSUL can also predict levels of rain noise that occur naturally, based on a statistical model of natural rainfall distribution.

The predictions are based on simple point force excitation theory as described by a number of reference texts, in particular Cremer & Heckl. The theory is also generally consistent with the methods used in EN12354-2:2000 Building Acoustics—Estimation of acoustic performance in buildings from the performance of elements. Impact sound insulation between rooms.

Users should be aware of the limitations, like any prediction tool INSUL is not a substitute for test data. Comparisons with test data show that it is generally within 3 – 5 dBA points for most constructions. However, as ISO 140-18 is relatively new, there is only a limited amount of test data available for comparison.

Drop Theory

The accuracy of the rain noise predictions depends critically on the input of a suitable impact force, in this case being a rain drop.

Three different drop shapes have been considered for rain noise predictions:

- Cylindrical drop as proposed by Ballagh;
- Cylindrical-hemispherical drop as proposed by Petersson;
- Paraboloidal drop as proposed by Petersson.

The paraboloidal drop, as proposed by Petersson, is used in the INSUL prediction routines. The drop shape and impact force over time, as described in Petersson's² paper, are shown below.

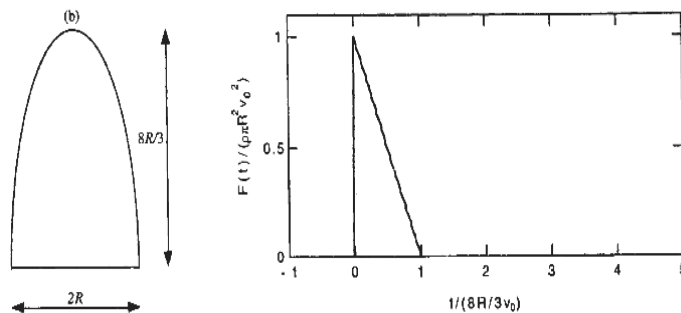

Figure 4. Calculated, normalised force versus non-dimensional time for a paraboloidal drop model at constant drop speed.

INSUL predictions calculate the impact force of each individual rain drop falling on the roof. These individual impacts are summed per unit time to determine the vibration velocity of the roof, which is then used to calculate the sound radiated from the panel.

Laboratory Rainfall (ISO 140-18)

ISO 140-18 was released in 2006 to provide a standardised method for the laboratory measurement of rain noise. The ambition of the standard is to provide a means of testing a range of roofing materials in a way that provides a robust comparison across materials, of the rain noise attenuation characteristics of the materials.

Rainfall used in the test standard uses drops of constant size, with a constant rainfall rate.

Four different rainfall rates are available:

- Moderate up to 4mm/hr
- Intense up to 15mm/hr
- Heavy up to 40mm/hr
- Cloudburst greater than 100mm/hr

The drop velocity is also specified in the standard and varies with rainfall rate.

² Petersson, B.A.T. 'The liquid drop impact as a source of sound and vibration' *Building Acoustics*, 2(4), 585-623.

Standard rain noise measurements use Heavy rainfall.

Rainfall is generated from an elevated water tank with a perforated base. The tank size can be fixed and may not cover the entire roof panel being tested. For example, this can mean that doubling the size of a test panel may not double the measured sound pressure level as the amount of rain fall remains fixed rather than doubling.

Measurements can be made as sound pressure level or sound intensity level. Results should be expressed as sound intensity levels.

Natural Rainfall

Natural rainfall predictions are based on a similar approach to that used for ISO 140-18 predictions. However, rather than modelling artificial rainfall from a tank of fixed size, rainfall rates are calculated based on a natural rainfall distribution model as described by Marshall and Palmer³.

For a given rainfall rate, the Marshall and Palmer distribution provides the number of raindrops in a particular size range, that are likely to fall in 'typical' natural rain. With natural rain it is assumed that the drops hit the roof at terminal velocity. Further details of this method can be found in a paper by Ballagh⁴.

An important difference between ISO 140-18 and Natural rain fall prediction is that the area of rainfall according to ISO140-18 is fixed independently of panel size. In contrast, with Natural rainfall, an increase in panel increases the effective area upon which rain fall is incident and, in turn, the predicted level of sound will increase.

³ Marshall, J.S. & Palmer, W. McK (1948). The distribution of raindrops with size, *Journal of Meteorology*, 5, 165-166.

⁴ Ballagh, K (1990). Noise of simulated rainfall on roofs, *Applied Acoustics*, 31, 245-264

Flanking Transmission

In all situations where sound insulation is important the transmission of sound by secondary or flanking paths should be considered. This is especially true when high performance partitions (STC/Rw 55 or greater) are to be used. Now that INSUL can predict the performance of triple panel partitions it is easy to design a partition that will have a high calculated or predicted performance in a laboratory test, but which will not achieve the desired sound insulation when installed on site, because sound will be transmitted around the partition by various flanking paths. The picture below shows a few of the possible flanking paths (in red). With 2 rectangular boxes joined together on one face there are 12 possible flanking paths that will contribute.

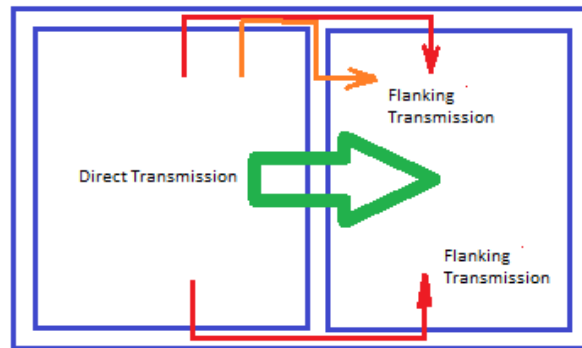

INSUL does not directly calculate the flanking transmission within a building. However version 7.0 introduces a visual reminder of the level of flanking transmission that might be experienced in a typical building, so that the user is reminded that flanking transmission must be allowed for, or special measures taken to reduce flanking, in order to achieve high sound insulation between spaces. A fuzzy pink line is shown on the graph, to indicate approximately the likely flanking transmission.

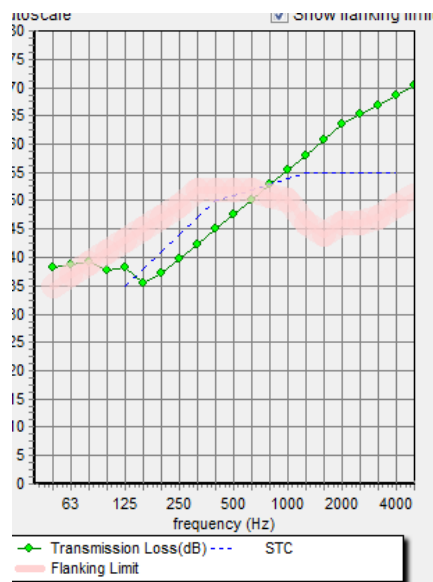

Note that the degree of flanking transmission is dependent on the type of building elements surrounding the partition. The user can select a flanking construction in the settings form



The flanking will be different depending on the weight of the construction and any vibration isolation in the structure.

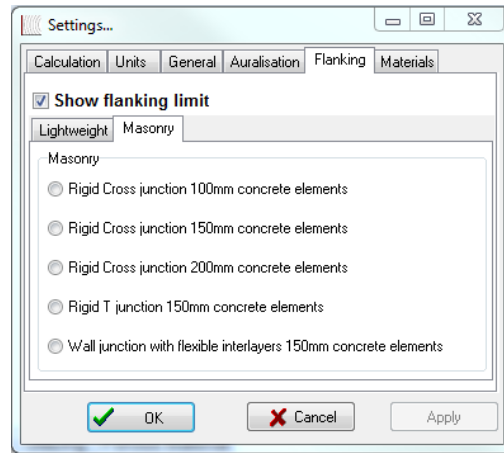

The European Standard EN 12354-1:2000 provides a simple method for estimating flanking transmission in masonry or heavy construction. INSUL incorporates a few simple results based on masonry construction of various thickness and junction details. For lightweight construction it is not practical at this time to calculate the flanking transmission and so experimental results have been used to predict the flanking for some ~~common constructions~~.

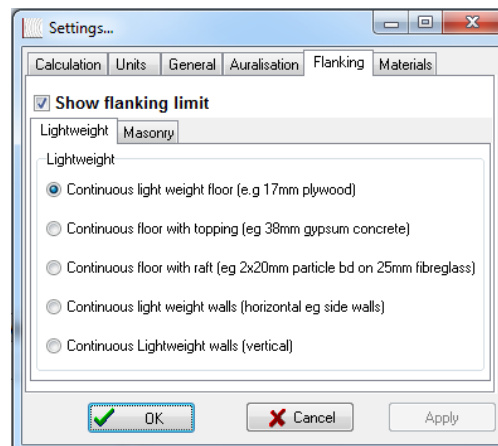

Flanking in Light Weight Structures

Flanking sound in lightweight structures is still an area of active research and tools for predicting flanking transmission in typical lightweight structures like timber framed buildings are still being developed. For INSUL at this stage of development we have chosen to use experimental data for some typical constructions and use that data as a guide for the user to determine when flanking transmission might contribute significantly to the overall sound transmission between spaces and when special measures might need to be taken to reduce flanking transmission.

The construction options in INSUL for which experimental data for flanking transmission are available are as follows:

- Continuous light weight floor (e.g 17mm plywood)
- Continuous floor with topping (eg 40mm gypsum concrete on resilient underlay)
- Continuous floor with raft (eg 2x20mm particle bd on 13mm fibreglass)
- Continuous light weight walls (horizontal eg side walls)
- Continuous Lightweight walls (vertical)

Materials Editor

INSUL 7.0 introduces a powerful new materials editor. There are a number of XML databases that hold information on solid materials, porous materials, floor coverings and steel profiles and the materials editor can be used to add to or modify these databases. The standard databases now contain all the materials available, for all Countries. The user can filter the data to show just the materials appropriate to their region (or country), or include materials from other regions. In addition, the user can add materials to the user's personal databases. By default, the user cannot edit the INSUL databases, but can make any changes to the user's database.

Updates of INSUL may overwrite the INSUL database but in general will not overwrite the user's databases.

It is important to know that there are separate databases for INSUL's list (maintained by INSUL developers) and for the user (custom materials maintained by you). Materials that INSUL maintains may be updated with new releases and it is recommended that you do not edit INSUL's databases. If you want to edit materials it is recommended that you add them to the users list as these will not be over written by new releases.

Insul relies on lists of information for its predictions, including lists of Materials, Profiles, Floor covers and absorptive infills. This information has traditionally been stored in text files without any easy, Insul-based ability to edit the files.

From Version 7, Insul includes a built-in Materials Editor. In addition to editing well established materials properties from the editor, a number of additional features have been added:

- **Regional materials lists** - Lists from one or several regions can be selected at the same time for use in Insul, providing access to materials files specific to a local region or across dozens of regions at once.
- **User materials lists** - Customised materials lists can be created in Insul to store information for specific materials and arrangements. The customized files are saved separately from the Insul list, and can be backed up and restored using the Insul Materials Editor. Custom materials show as blue in drop down boxes to distinguish them from INSUL's materials (shown as black in drop down boxes).

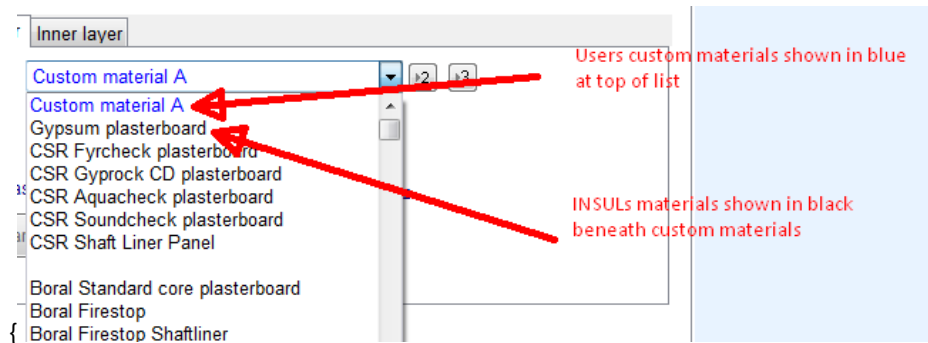

- **Locking materials** - Materials which are important can be locked, and saved, to prevent other users from editing or inadvertently deleting them from the lists.
- **Colour and Texture** - Colour can now be set and adjusted for all materials including insulation materials, glazing, floor covers and absorptive insulation. In addition, a brush pattern can also be saved, such as hatching, cross hatching and striping.

Regional databases

INSUL has built up databases for materials from many Countries. From version 7.0 onwards the databases are combined (into one file each for materials, absorbers, floor coverings, glazing materials and sheetmetal profiles). They are stored in the folder [COMMONAPPDATA\FOLDER]Marshall Day Acoustics/Insul70/materials.

The user can select to filter the database so that only the materials from one country are shown, or from many countries. The countries selected are shown in the status bar at the bottom of the main screen. The filter can be adjusted in the materials editor

User material lists

In addition to the built in database of materials the user can add their own materials. This is done through the Materials Editor. The databases are stored in [APPDATA\FOLDER]Marshall Day Acoustics/Insul70/materials. In general new releases or versions will not over write these files and users can maintain their own customised materials which are then available from the drop down lists to use. Note the users custom materials are shown in a blue font in the drop down boxes to distinguish them from the built in standard INSUL databases for which the font colour is black.

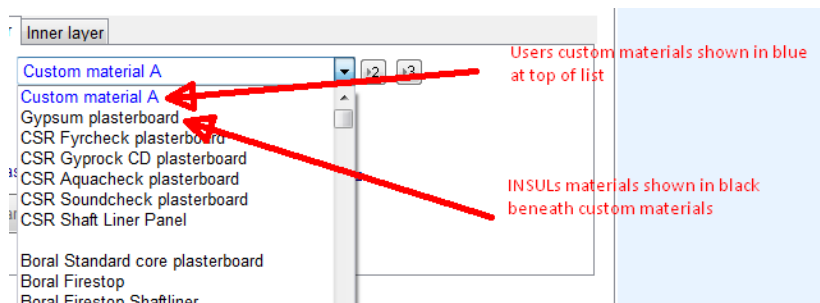

Import New Materials

It is possible to export and import new materials. For instance if you send material data to the Developers of INSUL they can (for a fee) analyse the data, and develop suitable material parameters and make up a new material. They can then email an xml file to you and this can be imported to your users materials file.

The pictures below tell the story better than words. In this case INSUL developers have set up a new material called "sandwich material" and exported the material to an xml file named "Export User Material.xml"

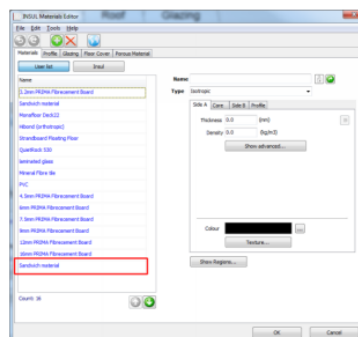
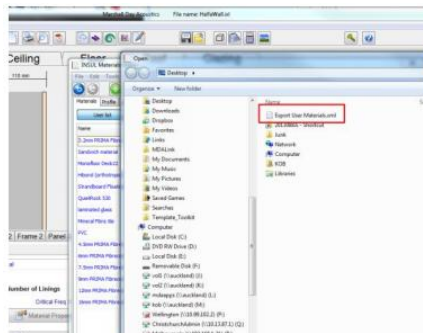
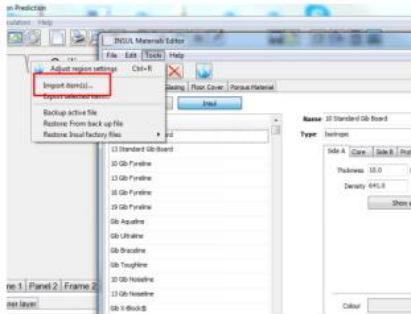
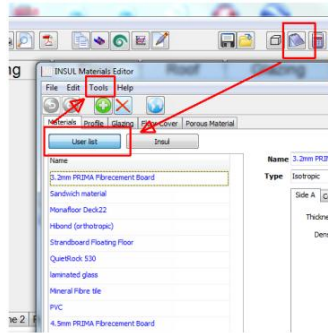

Panel 1 | Frame 1 | Panel 2 | Frame 2 | Panel 3 | Glazing | Porous Material

Outer layer: Inner layer

Material 9.2mm PRIMA Fibrecement Board (x2) (x3)

Thickness

Surface Mat

J.L. Pat

- 3.2mm PRIMA Fibrecement Board
- Sandwich material
- Monofloor Deck22
- Hibond (orthotropic)
- Strandboard Floating Floor
- QuietRock 530
- laminated glass
- Mineral Fibre tile
- PVC
- 4.5mm PRIMA Fibrecement Board
- 6mm PRIMA Fibrecement Board
- 7.5mm PRIMA Fibrecement Board
- 9mm PRIMA Fibrecement Board
- 12mm PRIMA Fibrecement Board
- 16mm PRIMA Fibrecement Board
- Sandwich material
- 16 Standard GIB Board

Serial No. 0001

Panel Size 2.7x4 m

Using INSUL

Insul Tabs

The Insul tabs are the primary control point for predicting sound levels.

Version 7.0 of Insul includes 5 main tabs:

- Wall
- Ceiling
- Floor
- Roof
- Glazing

By selecting a different tab, Insul will calculate predicted sound levels under various circumstances.

- Wall & Ceiling will calculate transmission loss or sound reduction levels for various wall and ceiling cavity constructions, using the elements of Panel 1 and Panel 2 as the linings on each side of the cavity construction.
- Floor will calculate impact sound insulation levels for various floor constructions with and without a ceiling.
- Roof will calculate rain generated noise levels for various roof constructions with and without a ceiling.
- Glazing will calculate transmission loss or sound reduction levels for various double and triple glazing constructions, with glazing types and thicknesses selected directly on the Single/Double/Triple Glazing tab.

Scrolling through tabs

Depending on the size of screen that is being used, it may be that not all the tabs are displayed on the Insul page control. If this is the case, the hidden tabs can be scrolled through using the scroll buttons at the top right-hand corner of the page control as shown below.

The screenshot shows the INSUL software interface. At the top, there are tabs for 'Panel 1', 'Frame 1', 'Panel 2', 'Frame 2', 'Panel 3', 'Glazing', and 'Porous Material'. Below these, there are sub-tabs for 'Layer 1' through 'Layer 6'. The 'Material' dropdown is set to 'SpeedWall panel (400kg/m2)'. The 'Category' is 'All'. The 'Thickness' is '78 (mm)' and the 'Number of Linings' is '1'. There are buttons for 'Material Properties' and 'Materials List Editor'. At the bottom, the 'Panel Properties' section shows 'Critical Freq 176 Hz', 'Surface Mass 40.1 kg/m2', and 'Panel Mode (1,1) 725 Hz Materialtype = InElastic Core'. There are also icons for a scroll bar and a calculator.

Single Panels

To predict the Transmission Loss (TL) of a single panel data is input into the appropriate spaces of the input form.

There are more than 500 materials whose characteristics are defined inside the program. To select one of these materials click the mouse on the downward arrow at the right hand side of the material input file, this will display a list of materials which can be selected by double clicking. The scroll bar on the list Box can be used to display more choices. The thickness of the material must be entered into the thickness field. The number of layers can be changed in the “no. of layers” field or by using the spin edit button to the right of the field. Note setting the number of layers to zero and initiating a calculation will cause an arithmetic error. To initiate a calculation, either click the left mouse button in one of the button on the left hand side of the tool bar (showing a symbol of gear wheels) or press control C.

Note you can have 6 different materials and/or different thicknesses of the same material by using the 6 layer tabs at the top.

To model a new material 3 parameters are needed, the density of the material, the product of critical frequency and surface mass (fcm), and the internal damping of the panel. The density is usually easy to determine either by direct measurement or from manufacturers data. The constant fcm can be determined either from a TL test on one particular thickness of the material, or it can be calculated from the elastic modulus of the material. Manufacturers can often provide data on the elastic modulus since it is usually needed for strength and deflection calculations for building materials. The damping constant can be determined from measurement or from TL test data. If no data is available it is reasonable to use a value of 0.01 which is very typical of many building materials.

If the material is not available in the drop down material list Box then the characteristics of the material must be input in the material constants dialog input Box.

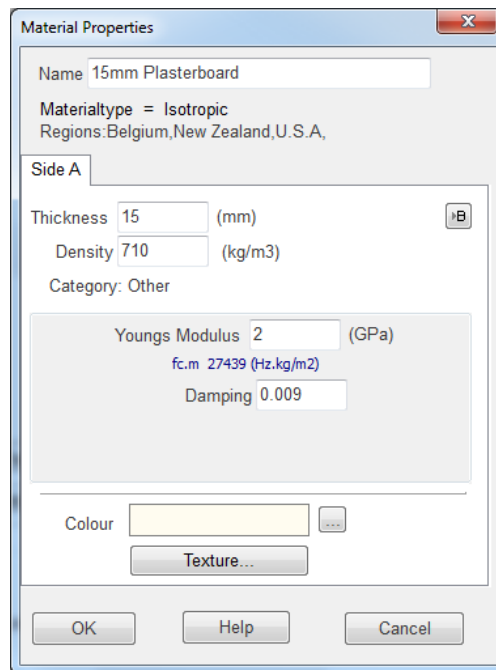

Clicking on the materials constants button on the input page accesses this. This has input fields for the material density, the fcm constant and the material dumping. Alternatively, if fcm is not known but the elastic modulus is known then this can be input, but the radio button to the left

of the input field for elastic modulus must be clicked. Once all material characteristics are input the dialog Box is closed by clicking on the OK button.

New materials can be permanently entered into the materials.txt file. This is a simple ASCII text file. See the section **New Materials** for details of how to enter new materials. If desired you can send Marshall Day Acoustics the details and we will customise the materials file for you.

Filtering of materials List

As the size of the materials files have grown over the years it has become more difficult to find the material you are looking for. Starting with version 8.0 there are two tools to help you, filtering or searching by description. You can select a "Category" from a drop down box just below the material selection list

There are at present 8 different categories:

- Gypsum
- Wood
- Masonry
- Fibre cement
- Glazing
- Insulated Panels
- Profiled Metal
- Other

If you select for instance Gypsum, then only the Gypsum board materials are shown.

Searching

Starting with version 8.0 you can find a material by typing into a search box a fragment of its name. For instance typing in 'crete' (but without the ' ', note the search has wild cards at each end of the string) will find Concrete or Light weight Concrete (depending on which regions you have selected).

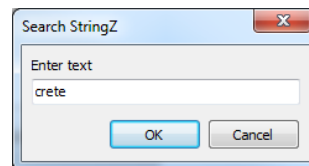

When you click on the materials selection you will find the materials matching the search.

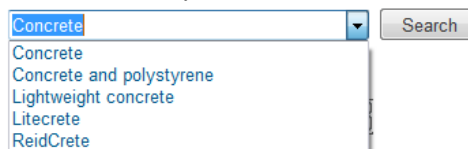

Double Panels

While it is rather simple and accurate to predict the TL of single panels, it is more difficult to predict walls that have two panels separated by a space. However, since this is such a common type of construction and since it can improve performance considerably various techniques have been developed. Indeed this is the main reason for using INSUL since it makes a complicated task quick and easy.

The easiest situation to understand and explain is two panels separated by an airspace with an absorptive blanket in the space between the panels. There is assumed to be no connection between the panels. At low frequencies the stiffness of the air between is so high relative to the inertia of the panels that the two panels are effectively locked together and more as one.

The TL is simply predicted from the mass law using the combined mass of the two panels. As the excitation frequency increases the inertia of the panels increases, at the mass-air-mass resonance frequency the inertia of the panel is cancelled by the stiffness of the air and the two panels move out of phase with each other.

As the frequency increases further the TL increases at a much greater rate than the mass law (up to 12 dB/octave). At even higher frequencies the separation of the panel becomes less than $\frac{1}{2}$ a wavelength and the cavity can now be modelled as a room with a single panel wall on each side.

To model a double panel or cavity wall click on the tab labelled wall and select the type of frame that best describes the connections between the two sides of the wall. Note that a drawing of a cross section of the wall appears in the panel above the input page showing the type of wall you have selected.

Single stud walls are walls in which the linings on both sides of the frame are rigidly fixed to each other; this is the most common type of wall.

Steel studs are a common type of wall framing in non-load bearing situations (eg office walls) which can be modelled by INSUL.

Double stud walls are modelled reasonably well as double panels without connections.

Enter the spacing between the inner faces of the two linings and the spacing between studs.

Triple Panels

The major improvement in Version 7 is the ability to model triple panel constructions. Previously constructions have been limited to panels on either side of an air-gap. But there are many common construction forms which include two air-gaps. For instance, it is common to have a masonry wall with plasterboard fixed to battens on each side. Such constructions can have excellent high frequency sound insulation, but with a pronounced dip in transmission loss at lower frequencies. INSUL 7.0 can model triple panel constructions consisting of several layers, with a range of connections between panels, and with and without sound absorptive material in the air cavity. It should be noted that the accuracy of triple panel predictions is less than for single and double panel constructions.

From version 7.0 INSUL can predict the performance of triple panel constructions such as that shown below.

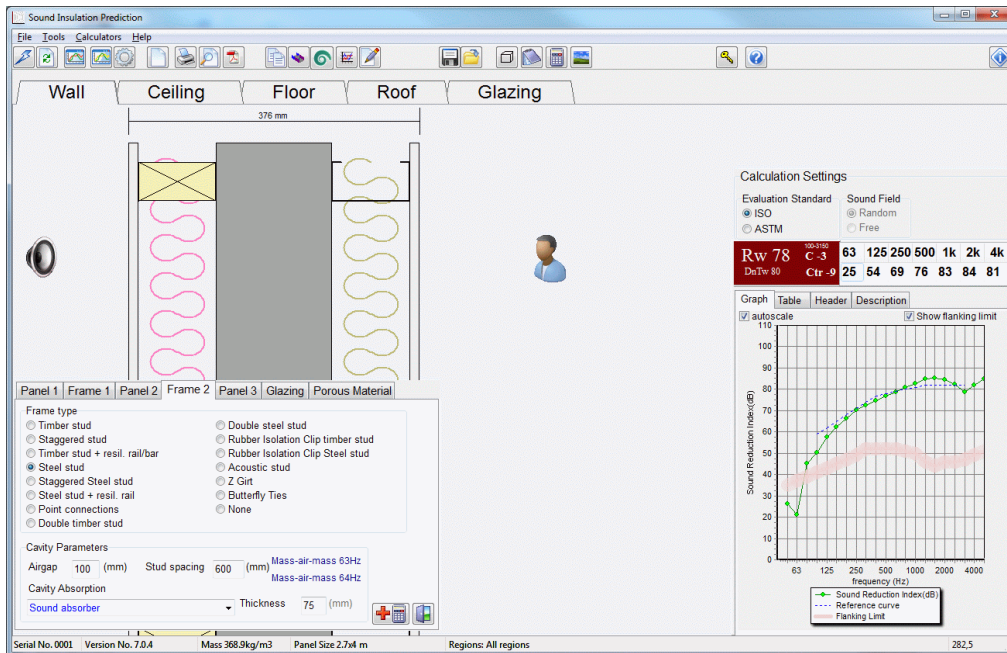

Use the tabs below.

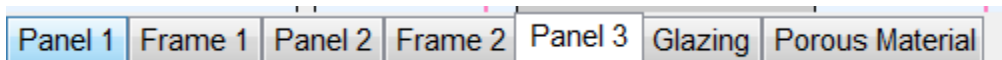

To predict triple panel constructions work your way across the various elements of the partition, entering or selecting the properties of each element (panel, frame etc) as you go.

The prediction of the transmission of sound through a triple panel construction is based on the same principles as for the transmission through double partitions. The basic theory for the behaviour of cavities and structural connections which has been used in INSUL for predicting double panel constructions has been found to be quite robust and applicable across a wide range of construction materials. Its extension to triple panels is a natural progression.

Warning

However a few things need to be borne in mind by the user. The accuracy seems to decrease as a function of the number of elements involved in the construction, and so for a triple panel construction the accuracy is appreciably less than for single and double panel constructions. From the available data that we have to compare the results of INSUL predictions against laboratory tests, the accuracy (90% limits) is estimated to be 4 dB for the R_w or STC index. A further warning is also in order, for some triple panel constructions (e.g. masonry walls that have plaster board linings on both sides) the STC rating is controlled entirely by the low frequency dip in the transmission loss curve due to the 8 dB rule. The accuracy of the STC rating is then even less because you do not get the averaging effect across a number of frequencies normally associated with the R_w or STC rating method. The STC is completely determined by that single frequency with consequently only the lesser accuracy of a single band.

Roof

Rain noise calculations

The roof materials you would like to model can be set on the Panel 1 tab, as is done when modeling a wall, ceiling or floor.

To predict the level of rain noise for a construction, click on the Roof tab.

Panel 1 | Panel 2 | Wall | Ceiling | Floor | Double Glazing | Roof

Rainfall
 Moderate Intense Heavy Cloudburst

Rainfall 40 mm/hr Drop diameter 5 mm Rain Velocity 7 m/s

Ceiling

Frame type
 Solid joist(timber or Twinaplate) Rubber Isolation Clip
 Suspended light steel grid Separate joists
 Resilient clip or channel

Airgap 300 (mm) Joist spacing 450 Mass-air-mass 46Hz

Cavity absorption
R 1.8 Pink Batts Thickness 75 (mm)

Laboratory rainfall (ISO 140-18) Natural rainfall

On the roof tab, there are two page options:

1. Laboratory rainfall (ISO 140-18)
2. Natural rainfall.

Laboratory rainfall (ISO 140-18)

Select the Laboratory rainfall (ISO 140-18) page on the Roof tab.

Four different rainfall rates are available, Moderate, Intense, Heavy and Cloudburst.

Natural Rain

Select the Natural rainfall page on the Roof tab. Enter the rainfall rate you would like to use in the edit box at the top right hand corner of the Roof page.

Panel 1 | Panel 2 | Wall | Ceiling | Floor | Double Glazing | Roof

Rainfall rate 40.0 mm/hr

Ceiling

Frame type
 Solid joist(timber or Twinaplate) Rubber Isolation Clip
 Suspended light steel grid Separate joists
 Resilient clip or channel

Airgap 300 (mm) Joist spacing 450 Mass-air-mass 46Hz

Cavity absorption
R 1.8 Pink Batts Thickness 75 (mm)

Laboratory rainfall (ISO 140-18) Natural rainfall

Profile panels

The roof panel profile can be set on the properties form to:

- Flat
- Corrugated
- Ribbed

The corrugated profile is useful to model roof panels such as corrugated iron or steel. Refer to Ribbed and Corrugated Panels and Single Panels help pages for further details about panel profile.

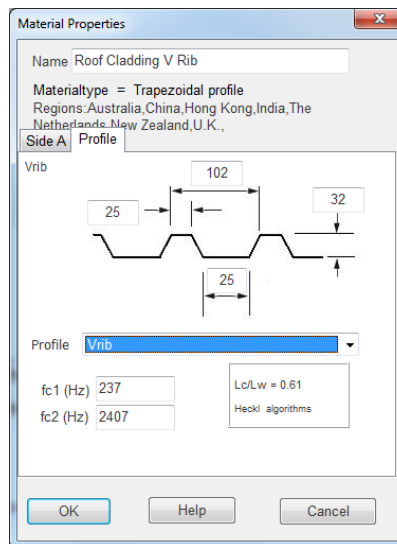

Ceiling

Ceiling lining panels can be set from the Panel 2 tab, just as is done when modelling a ceiling or floor.

If you would like to model a ceiling in your rain noise prediction, click the ceiling check box. This will make active the ceiling selection section on the Roof tab page.

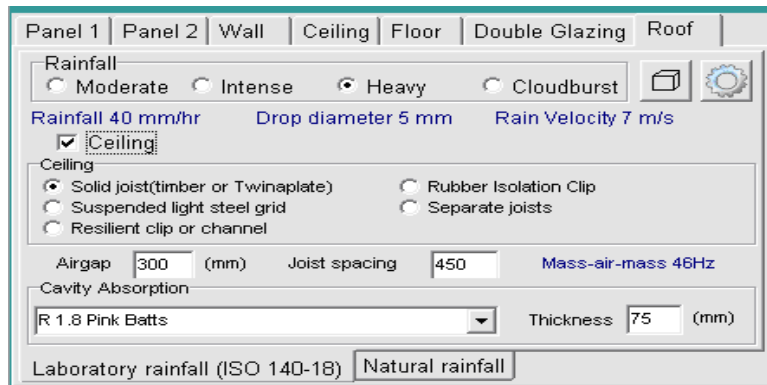

You can use these ceiling properties to select the ceiling arrangement you want. You can specify different ceiling connections, the air-gap and joist spacing and the type and thickness of any insulation used in the cavity. The controls on the roof tab page are the same as those shown on the Ceiling tab.

The ceiling controls are linked across the Ceiling, Floor and Roof tabs. If you make a change to the ceiling arrangement shown on, for example, the Floor tab, these changes will be carried across to the Ceiling tab and the Roof tab.

Panel size

The roof panel size can be set by clicking on the Room properties button on the Roof page.

The roof panel size can also be set by clicking on the Room properties button on the main tool bar.

IMPORTANT: Changing the panel size can have a significant effect on the predicted rain sound level. It is important to set the roof panel size to match the panel you would like to model.

Reverberation time and room volume

To set the reverberation time and room volume, open the Room properties window, by clicking on the Room properties button on the Roof page

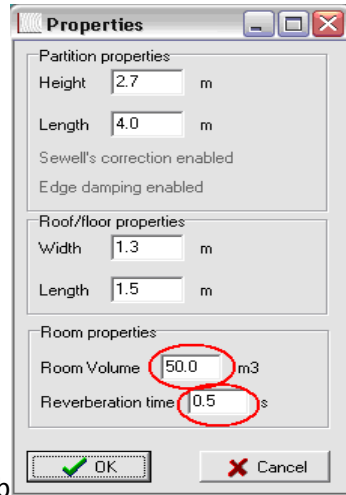

The reverberation time can be changed using the edit boxes.

Changing the reverberation time and room volume is important when predicting rain sound pressure levels.

Outputs

Insul can predict rain sound levels as:

- sound power levels;
- sound pressure levels;
- sound intensity levels.

To set the type of output, click on the settings button on the Roof page.

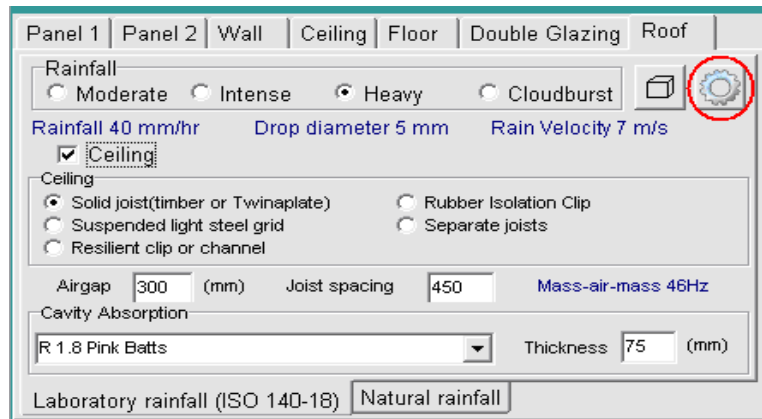

The output settings can also be changed from the file menus: Tools>Settings>Calculation>Roof.

When the Settings menu is open, the output type can be selected from the three options available.

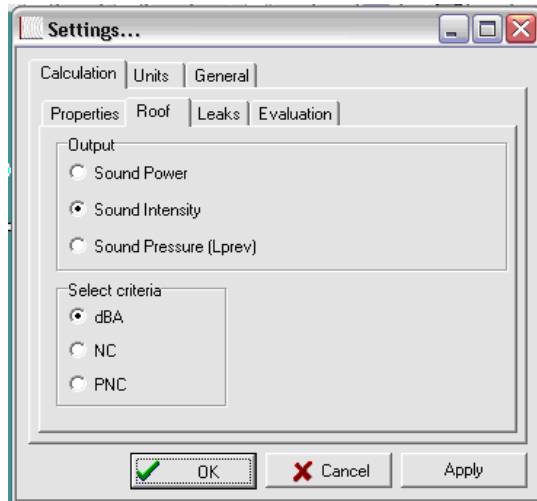

When sound pressure is the selected output, the reverberation time and room volume become important. These can be set from the Room properties window.

The single figure index for the predictions can also be set from this menu. dBA, NR and NC are available.

Using the Materials Editor

The Materials Editor can be opened from the Settings Menu or from the button on the

toolbar . The settings menu select the Calculation Tab, and Materials Tab, and open the editor.

The Materials Editor provides the ability to directly create, edit and delete INSUL's and the users custom lists for:

- Insulation materials
- Profiles
- Double/Triple glazing
- Floor covers
- Absorption materials

There are Tabs in the editor for each of these lists. Select the tab you wish to view a given list.

For example, select the Insulation materials Tab. Insul's insulation materials are shown on the list at the left hand side of the Insulation materials Tab. To select a new material, scroll through the items on this list.

The details for each item on the list are provided on the right hand side including an items Name and Type and properties such as Density, Thickness and Colour. As each new item is selected, the details update.

Editing occurs in real time, editing any of this detailed information will edit the underlying Insul files.

Advanced information for an item is hidden in the initial editor view. To view advanced properties, such as Youngs Modulus and Damping, click the Show Advanced button.

To change the colour of an item, click on the coloured panel and select a new colour from the colour dialog. To select a brush pattern for the item, click the Texture button.

Each item now includes a Regions property, which describes the various Region lists within which the item can appear. To view the Region properties for an item, click the Show Regions button and view the Region window that appears. Selected regions will appear in black text, unselected regions will appear in grey. To change the regions selected for that item, double click the Region window.

The green up and down arrows at the base of the list on the left hand side will adjust the position of the selected item in the list. The order of the materials in the Materials Editor is the same as in Insul.

To create a new item, click the green plus from the Tool bar at the top of the form. If you wish to create a new item by duplicating an existing item, select the existing item, and click the small button, near the Name edit box.

To lock a material to prevent future editing, click the locking button, , which will update to show a lock, and the detailed information for the item will disable. To unlock the item for editing simply click the button again.

To delete an item, select the button with the red cross from the Tool bar at the top of the form.

To Undo or Redo any action, use the Undo and Redo buttons at the top left hand side of the form.

Insul now has the ability to display lists of materials for one or several regions. To select the regions that are displayed by Insul, click the Globe button from the Tool bar at the top of the form. From the resulting dialog, the Region or Regions to be viewed can be selected from a list of check boxes. A View All option is also available. When this dialog is closed, the Materials Editor will update to display all items from all selected lists.

To create new materials or customized materials it is recommend to use the inbuilt User List. To select the User List, click the User List button at the top left hand corner of each of Tab page. This will toggle the view from the Insul list to the User list. The Insul list displays items in black text. The User list displays items in blue text.

Customised materials can be created, edited and deleted in the same manner as Insul items, as outlined above. When the Material Editor is closed, Customised items appear at the top of the list within INSUL, in blue text.

{bmc MaterialsList.png}

An advantage of adding unique materials to the Customised list is that this can be saved and restored to Insul from the Materials Editor>Tools menu.

Future updates for Insul may include new Insul lists for one or several materials. Saving unique or customized materials in the User List means that they will not be overwritten during a future Insul update.

The Materials Editor may be closed either by clicking the OK or Cancel buttons, or the exit button at the top right hand corner of the form. Selecting the OK button will save all changes to the Materials

Files, and refresh Insul so that the changes appear immediately for modeling. Selecting Cancel or Exit will close the form without saving any changes. The existing Insul materials files will not be updated.

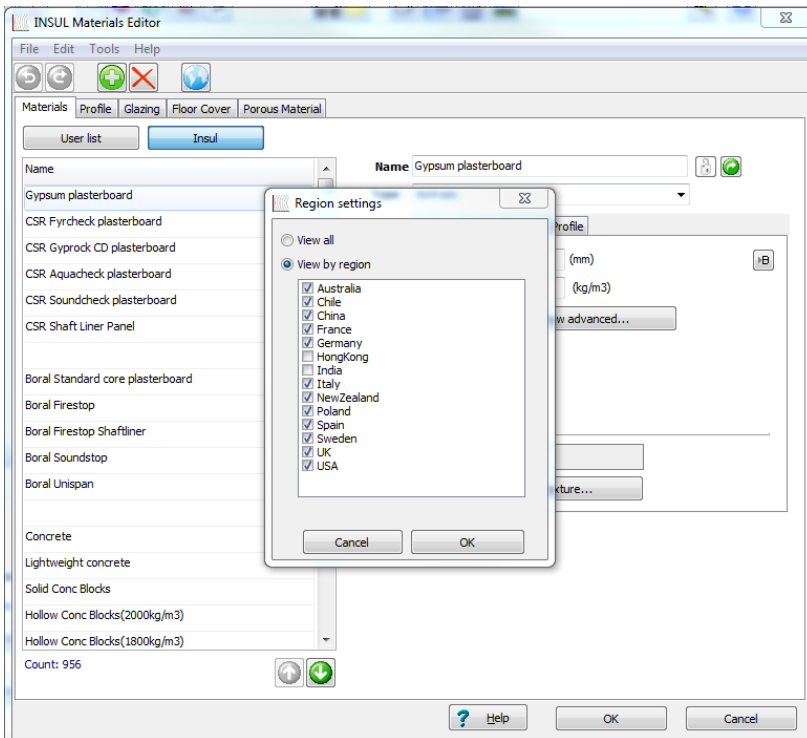

Saving and retrieving files



It is possible to save the details of a construction for future reference. Click the button on the top tool bar that has a picture of a diskette. This will bring up a file dialog Box. Click in the filename Box and enter the file name that you want it saved as. If you want to save in a different directory you can use the standard windows file directory tree to navigate to the desired directory. If you don't type in a file extension it will automatically give the file and extension of ins. You may recall a file at a later stage by clicking on the button on the top tool bar that has a picture of a folder. This will bring up a file dialog Box. This works similarly to other windows programs, for instance you can double click on the file you wish to recall, or type its name into the edit Box.

Comparison



INSUL includes a feature to allow immediate comparison of the TL of different constructions. The buttons with a graph with 2 lines on it when clicked will memorise the graph of the current construction. The TL of the previous construction will be shown in red or yellow so that you can see immediately how your changes have affected the TL at different frequencies. You can also use CTRL-S to set this comparison. The red or yellow comparison curve remains until you either set a new comparison or reset it (which sets it to zero). (Use the option under the File Menu).

Reference

Sometimes you may have an existing partition with test data available and you want to use INSUL to predict changes. In this case you can enter the test data onto the graph so that you can see how closely INSUL models the existing partition and if necessary you can adjust the model for best agreement before modelling the changes. You can do this by clicking on the tab labelled Table and entering the data into the grid in the column headed **Ref**. You must then click the checkbox marked **Display ref spectrum** just next to the table, where upon the test data will appear in pink on the graph for easy comparison. You can turn off the display by un-checking the box. Another reference spectrum can be displayed in the Ref 2 column again using the checkbox marked **display ref2 spectrum** to turn on or off the display of this data. Data may also be pasted from the clipboard using the two buttons to avoid having to manually enter the data



Outdoor to Indoor Transmission

INSUL is primarily a tool for predicting the sound transmission loss of a wall or floor. However a simple calculation tool has been added for working out the overall transmission of noise from outside to inside. For instance with aircraft or road traffic noise incident on a house or the facade of an apartment, what will be the noise level inside a particular room. INSUL can now be used to complete this calculation

Calculation Form

Open up the calculation form by clicking on the  button on the toolbar

You will see a form like that below with places to enter the relevant data. The light blue indicates the cells where you should enter data. Note that in general you need to enter data at every frequency.

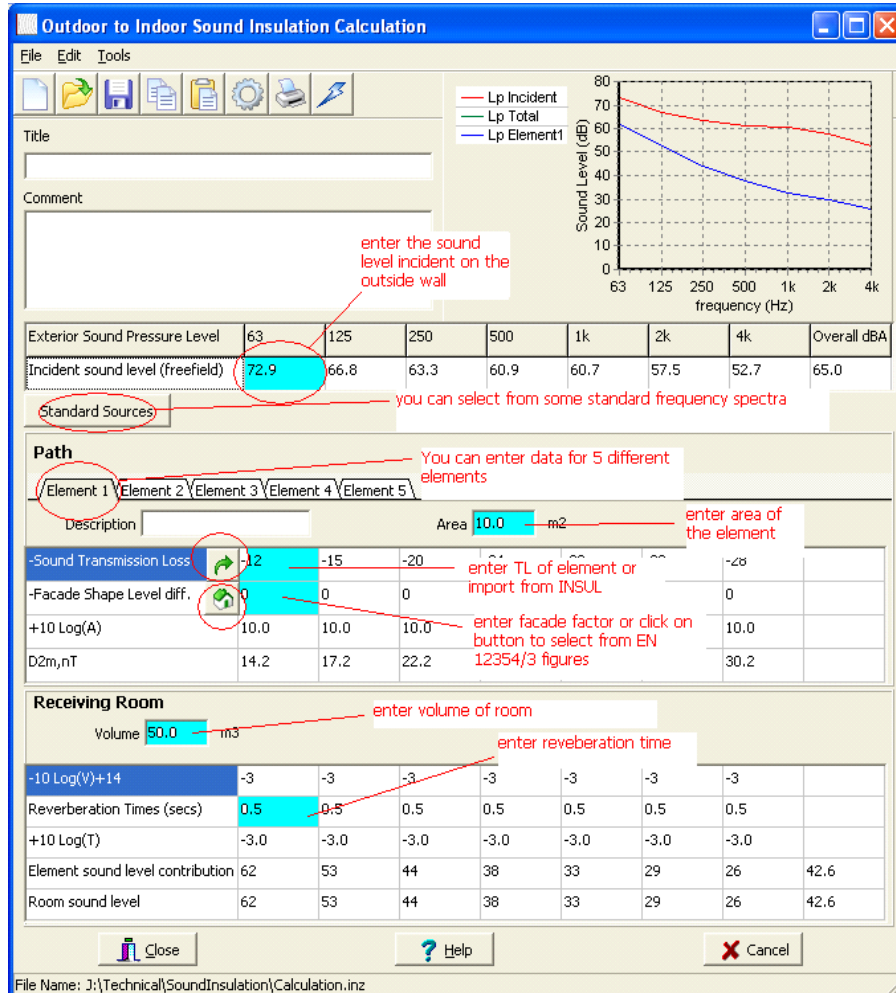

Extra data required

In addition to the sound transmission loss of the wall (predicted by INSUL) we also need to know the outdoor noise level incident on the wall, the area of the wall, and the volume and reverberation time of the room. There may be several elements to the facade, such as the main external wall construction, a window and an additional transmission path through a side wall. The sound transmission loss and area of each path must be known or estimated.

Outdoor noise level

The sound transmission loss is a function of frequency and in general the outdoor noise will consist of a mixture of different frequencies. Thus the calculation must be made over the normal audible frequency range. INSUL can be set to do this in either octave or 1/3 octave frequency bands. The choice of frequency bandwidth will generally be determined by whether the data is available in octave or 1/3 octave bands. There is a handy calculator which you can use to calculate the frequency spectrum for different noise sources if you know the A weighted noise level (dBA).

Reverberation Time and Room Volume

The reverberation time can often be estimated with reasonable accuracy from a knowledge of the room and its furnishings. It is a convenient phenomenon that for general living spaces such as bedrooms and living rooms the reverberation time of most rooms turns out to be close to 0.5 seconds and reasonably flat across the frequency range. Thus for domestic rooms in the range 20 m³ to 200 m³ you can use 0.5 seconds at all frequencies as a reasonable estimate. For different rooms that are either much larger or more sparsely furnished the reverberation time should be either calculated or measured.

Façade Shape Level Difference

As noted in EN12354 the facade of the building can affect the sound transmission by either shielding or reflective effects. The afore mentioned standard contains a table of corrections to be applied to the calculations depending on the facade arrangement. In INSUL you can click on the button that has a picture of a house. This brings up a form that shows the vertical cross sections of some different arrangements. Click on the picture most closely describing your situation. The effect of reflection from an over-hanging balcony above, and whether this balcony has absorptive surface, and the shielding effect of ones own balcony front can be allowed for.

For other situations one can enter you own value in this row. Based on consultants experience our current practice is to use

- 6 dB factor for the shielding of a side wall which is not directly visible by the source,
- 3 dB for a roof, and -10 dB for a rear wall.

These values are for guidance only and may be updated as more current research and experience becomes available.

Angle of incidence (you don't need to read this if you don't want to)

An often overlooked factor with outdoor to indoor calculations is that all sound transmission loss data that is commonly provided is measured (or calculated) for a random incidence field on both the source and receiver side of the partition. Yet as acoustic text books point out, the sound transmission loss of a partition will vary with angle of incidence, reducing as the angle of incidence approaches grazing incidence. Thus you would expect that the transmission loss of the facade and hence the internal noise level in the room should vary with the angle of incidence of the external noise. However research undertaken by Rindel (Transmission of Traffic Noise through Windows. Influence of Incident Angle on Sound Insulation in Theory and Experiment, report no 9, DTU Denmark 1975) shows that for finite sized partitions (i.e. not infinite sized partitions) and for low and mid frequencies there is little actual influence of angle of incidence on the "External" transmission loss.

To explain this in a different way, in classical acoustics the sound transmission loss (defined in terms of incident intensity) tends towards zero at grazing incidence. However the incident sound power will also tend towards zero because the projected area the sound wave is incident on tends to zero. Thus it is not clear what wins, the incident level tends to zero but the transmission loss tends to zero also. What will the internal level be? Rindel avoided the confusion by defining the "External Transmission Loss" as the ratio of the energy densities of the sound fields on the source and receiver sides.

The external energy density does not go to zero and the External transmission Loss can be estimated from the traditionally measured random incidence transmission loss. These effects are included in the outdoor to indoor calculations carried out by INSUL. The same effects are included in EN 12354/3 in section 4 when it describes the general principles of the calculation model. The apparent sound reduction index of the facade is given as equal to the random incidence sound transmission loss.

Thus trying to reach a simple conclusion, the answers calculated by INSUL are a good prediction for noise that is incident from a range of different angles of incidence (e.g. traffic noise) and furthermore is a reasonable approximation for most building facades for any angle of incidence. The answers for specific angles of incidence could be in error at frequencies above 1 kHz. For either normal incident sound or for grazing incidence sound, the maximum expected error at say 4 kHz would be +/- 3dB, and for most noise sources these frequencies would not determine the overall loudness of the internal noise.

Sound Source

Very Important Note

The source sound level to be entered into the calculation sheet is the sound level incident on the building facade, but measured or assessed with the building not there. It is the free field level. If you have a noise level measured in the presence of the building then this measured level will include some reflection from the facade. In general if you measure 1 to 2 metres from the facade the noise level will be about 3 dBA higher than the free field level (i.e. with the building not there).

Frequency Spectrum

The noise level inside the room will depend on the frequency spectrum of the noise source. For instance noise from nightclubs or bars will often contain a lot of low frequency sound energy and light weight building elements like windows will provide only a small amount of attenuation of that noise. Therefore it is important that the frequency spectrum of the noise is either known or can be estimated with reasonable accuracy. INSUL contains a small calculator which can estimate the frequency spectrum if the overall A-weighted noise level is known. For instance traffic noise can be estimated reasonably well in free flowing conditions from a standard spectrum given in ISO 717, or male speech spectrum can be estimated from ANSI S3.5. Click on the button labelled "Standard Sources" and the following form will appear.

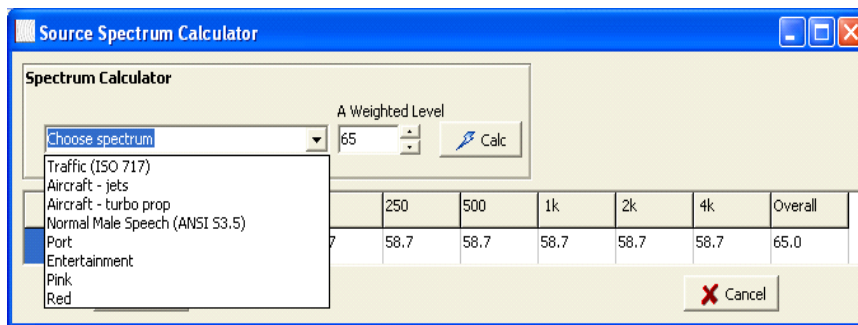

Choose the type of source from the drop down box and set the overall A weighted level. You can also cut and paste a spectrum into the Source Grid back on the Outdoor to Indoor Form using Control C when the cursor is positioned on the 63 Hz cell

Octaves versus 1/3 Octaves

Acoustic calculations are generally required to be carried out at a range of different frequencies. The Outdoor to Indoor Calculation in INSUL can be carried out either in Octave or 1/3 Octave bands. The choice is primarily dependent on the information available and the degree of accuracy required. Traditionally octave bands have been used for engineering calculations, probably because historically this sped up calculations by a factor of 3 without much loss of accuracy for most purposes. For many noise sources which are broad band in nature (e.g. traffic noise) the change in precision between use of octave or 1/3 octave bands would be minute. If you have all the data available in 1/3 octave bands then there is little point in not using it. If however some of your data is only in octave bands then use octave bands.

INSUL can be set to use either octave band data or 1/3 octave band data. Go to the settings page and choose the bandwidth.

Standards

INSUL calculates in accordance with

- EN 12354-3:2000 "Building Acoustics - Estimation of acoustic performance of buildings from the performance of elements - Part 3: Airborne sound insulation against outdoor sound".

D2m,nT

INSUL displays this quantity on the calculation form. If you are not familiar with ISO standards then this needs some explanation. This quantity is a standardised measure of facade performance. It is the difference between the outdoor sound level measured 2 metres from the facade (thus including the effects of reflection from the facade) and the spatial average sound level inside the receiving room, when the receiving room has a reverberation time of 0.5 seconds (at all frequency bands). This quantity will vary somewhat depending on the volume of the room and the area of facade exposed so it is not a unique quantity of the partition.

What is Composite Transmission Loss?

If a partition comprises, say, 75% steel stud wall and 25% glazing, the sound reduction or transmission loss through the steel stud wall will be different from the transmission loss of the glazing.

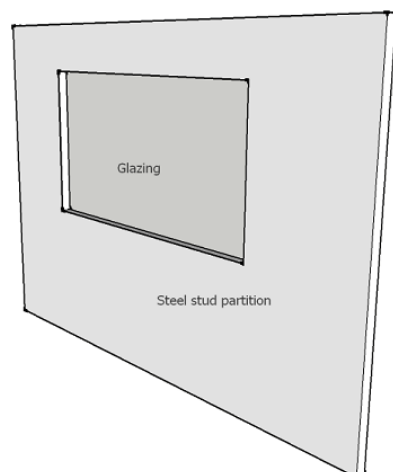

So what will be the transmission loss of the overall partition?

The theoretical transmission loss of the overall partition is called the *Composite transmission loss* or *Composite TL*.

Composite Transmission Loss Equations

The composite transmission loss can be calculated as the average of the transmission coefficients () of the individual elements that make up the partition. The average is weighted, according to the surface area (S) of each of the elements.

$$R_{Total} = -10 \log_{10} \left(\frac{1}{\sum_{n=1}^N S_n} \sum_{n=1}^N S_n \tau_n \right)$$

Composite TL Calculator functions

Octaves versus 1/3 Octaves

Octave and Third Octave sheets are available in the Composite TL Calculator

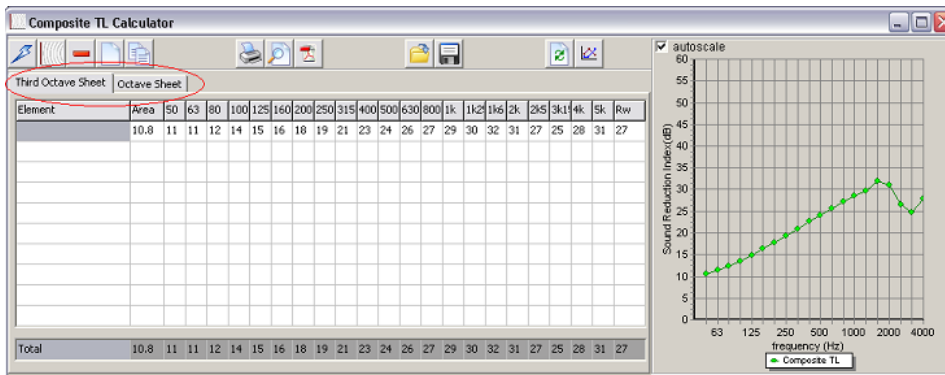

- transmission loss data added to the Composite TL Calculator from Insul will be added in 1/3 octave bands.
- Data added to the Third Octaves Sheet is converted by the Composite TL Calculator into octave band data which is displayed on the Octaves Sheet.
- Data added to the Octaves Sheet cannot be converted into 1/3 octave data. When values are manually entered into the Octaves Sheet the Third Octaves Sheet will be zeroed and will appear as follows:

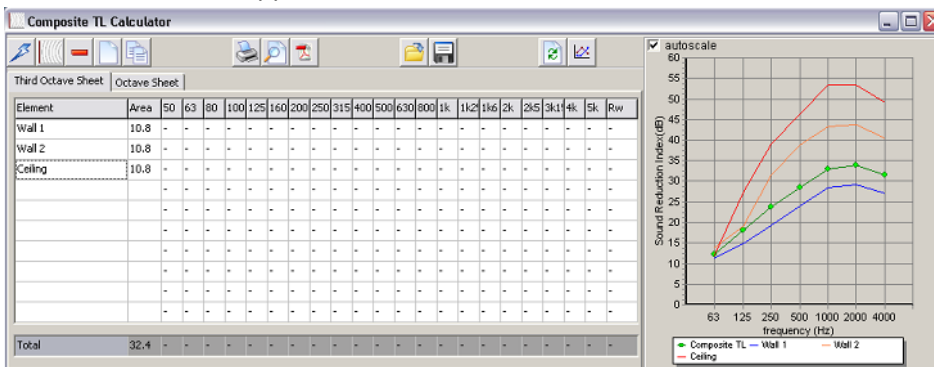

Delete data

Click  to delete a row of data. The row which contains the selected cell will be deleted and all values in that row will be set to zero.

Reset calculator

Click  to reset the Composite TL Calculator and clear all data.

Printing

A sheet can be printed which records each set of transmission loss data in the Composite TL Calculator including the composite transmission loss. There are 3 buttons associated with printing.



The first button,  when clicked will display a print dialog box which enables the user to do the usual selection of printer properties etc before sending the page to the printer.

The second button,  displays a preview of what will be printed. (Due to the generally poorer resolution of screens compared to printers this will not look exactly the same as the printout).

The third button  will generate an Adobe Acrobat file of the printout. This is a fairly universal format that enables, for instance, the user to email printouts to others. The receiver will require the Acrobat reader which is free to download from the Adobe site <http://www.adobe.com/products/acrobat/readstep2.html>

Clicking  there is also an option to generate a pdf printout and save the file simultaneously. On the dialog window that appears:

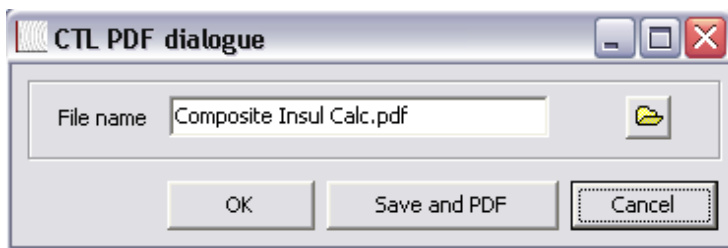

Click the *Save and PDF* button.

Save

It is possible to save composite transmission loss data for future reference.

Click the  button on the Insul Toolbar.

This will open a Windows file dialog Box. Click in the filename Box and enter the name the file is to be saved as. To change to a different directory use the standard windows file directory tree to navigate to the desired directory. If a file extension is not included in the filename, the file will be saved as a .cns Insul file.

Open

You may open/recall/load a file at a later stage by clicking on the  button. This will bring up a file dialog Box. This works similarly to other windows programs, for instance you can double click on the file you wish to recall, or type its name into the edit Box.

Toggle STC/Rw

Click the  button to toggle between STC and Rw single figure indices.

Show/Hide plots.

Click the  button to show/hide element plots.

When the element plots are hidden, the chart displays only the Composite TL data plotted as a green curve.

When the element plots are shown, the chart displays a plot for each set of transmission loss data that is entered into the Composite TL Calculator. A different line colour is used for each set of data. An example composite transmission loss calculation with element plots shown is provided in the image below.

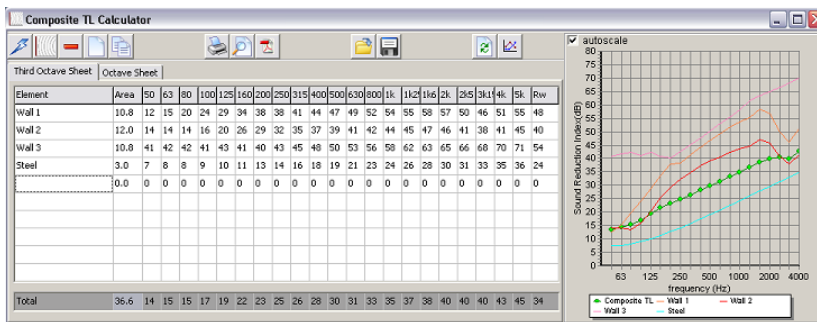

Auralisation

The user can now listen to the predicted sound reduction. Using, for instance, headphones plugged into the computer sound output, the user can click on a simulation of sound on the source side of the wall, then on the receiver side of the wall. This provides a very interesting tool for users to be able to listen to the effect of different walls. However, the user should be careful that the accuracy of the simulation will depend on the frequency response of the reproduction system and the background noise level. So demonstrating differences in low frequency performance with headphones may be quite ineffective. Likewise, trying to listen to the effect of very high performance walls may be impossible if the background noise is not very low.

Remote Update of Insul USB Key

The Hasp key which is required to run INSUL has the version number which the customer has purchased stored in it. When an update is purchased the key must be updated before it will allow the new version to run. This can be done without returning the key to the Distributors or the Developers.

Upgrading Insul Keys

Starting with Insul version 6.2, the usb keys can be upgraded without needing to be returned to the developer or distributor. The process is for the user to generate a file from their key using Insul, this file is sent to the developer who generates an update file. This update file is sent back

to the client who then uses Insul to update their key. The key can be upgraded to a new version or other software can be added to the key.

1. Start Insul and then click on the remote update button on the tool bar (see below).
2. Click on the "Save Key Information to file" and save the file (*.c2v). This produces to a convenient location and then email it to the Distributor or the Developer (insul@insul.co.nz).
3. An update file will be emailed to you that can be used with Insul to update the key to the new version using the "update Key from file" button. Browse to the update file sent to you by the developer or the distributor. This will be named something like "0101key1300.v2c". Open this, Insul will then update the key and display a message that the key has been updated successfully. The key should now have the new information loaded and should unlock the new version of Insul.

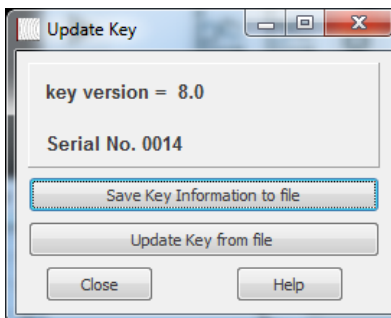
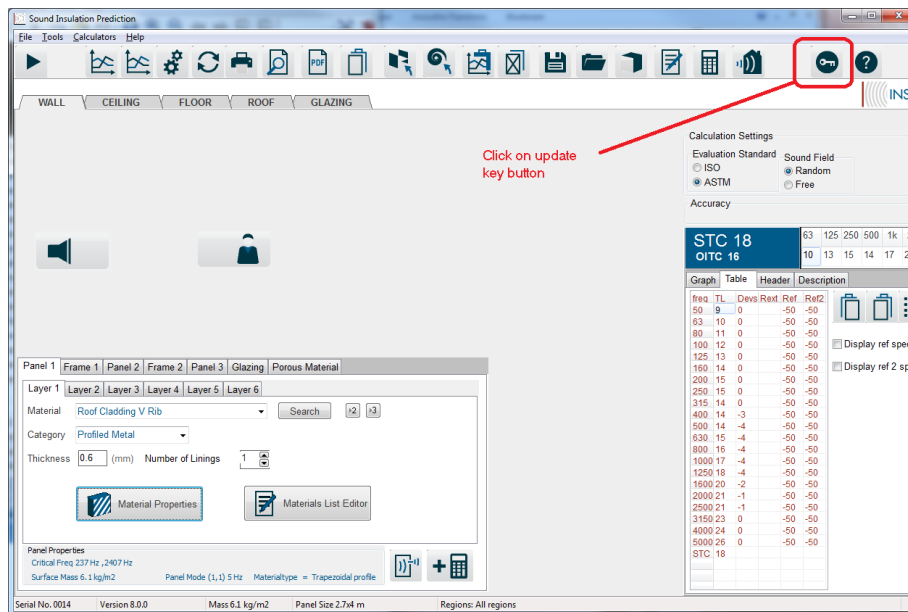

Clipboard



The transmission loss data can be copied to the Windows clipboard by clicking on the left-hand button shown above. The data can then be transferred to a spreadsheet or similar. The format is given below.

50	13.4
63	14.3
80	15.5
100	16.8
125	16.7
160	21.7
200	25.9
250	29.7
315	33
400	35.7
500	37.8
630	39.3
800	41.2
1000	42.8
1250	44.3
1600	45.7
2000	46.6
2500	47.8
3150	45.9
4000	40.2
5000	42.1
STC	39

The user can also copy the graph  , or a picture of the construction .

Settings

To open the Settings windows either:

- Click the  button
- From the Tools menu select: Tools>Settings...
- Pressing *Ctrl+I*, from the Insul main page.

Calculation Settings

Click the *Calculation* tab in the Settings window to adjust various calculation parameters.

- Sewell's Correction and Edge Damping can be turned on and off from the *Properties* tab.
- Roof (rain noise) output and single figure index can be selected from the *Roof* tab.
- The calculation algorithm for Slits and Apertures can be selected from the *Leaks* tab.

The evaluation method (ISO or ASTM) can be selected from the *Evaluation* tab, as can the frequency range for assessment of the C correction when using the ISO 717 evaluation method.

Units

Click the *Units* tab in the Settings window to change units between Metric and English.

Important: Insul must be restarted after changing the units for the changes to be made correctly.

General

Click on the *General* tab to change the language for Insul and also to change the colour of the background panel and activate a Custom Logo.

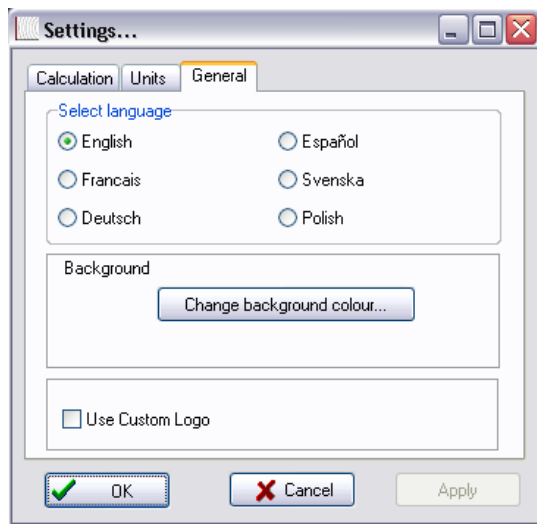

Custom Logo

Users can insert their own logo into the printout. The logo should be in the form of a bitmap file, named logo.bmp and stored in the Insul folder (this is usually C:\program files\marshall day acoustics\Insul64)

To activate the custom logo, open the Settings window, select the *General* tab and check on the box marked *Use Custom Logo*.

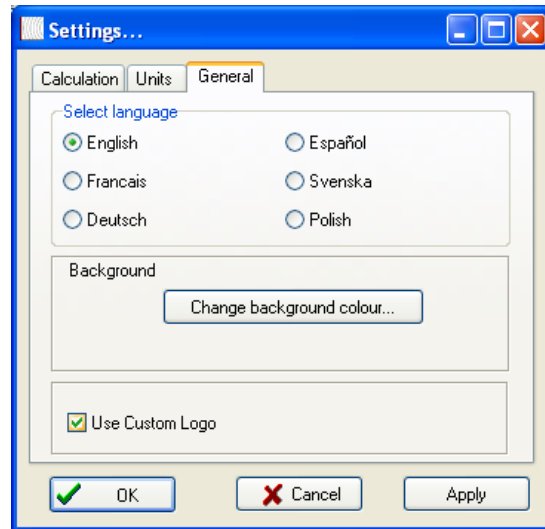

Limitations

Users should be aware of the limitations of INSUL software, like any prediction tool it is not a substitute for test data. Comparisons with test data show that it is generally within 3 STC/R_w points for most constructions, however the accuracy reduces with increasing numbers of panels and layers, and when there are any resonance frequencies near the edge of the R_w/STC criteria curve. If in doubt about the accuracy of prediction please consult the developers.

Contact Details

Marshall Day Acoustics
PO Box 5811
Auckland 1141
New Zealand
ph 64 9 379 7822
fx 64 9 309 3540
www.marshallday.com
insul@insul.co.nz